

DIN 608 (4.8, 5.8)

Pluhové šrouby se čtyřhranem s maticí DIN 934 (8.8)

NEJČASTĚJŠÍ POUŽITÍ

Šrouby **do strojů LEMKEN**

Nejčastěji používaný kód je **OEM LEMKEN 3015785 12 x 35**

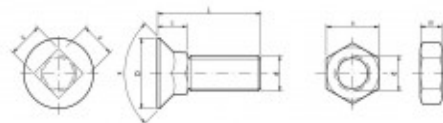

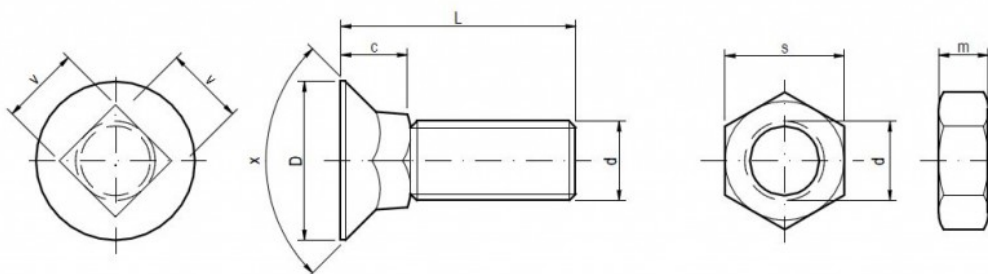

Specifikace

d	c	D	x	v	s	m
M 10	8,00	19,00	90°	10,00	17,00	8,00
M 12	10,50	24,00	90°	12,00	19,00	10,00
M 14	11,00	28,00	90°	14,00	22,00	11,00

Šrouby DIN 608 jsou vhodné do strojů OEM LEMKEN, ÖVERUM, PÖTTINGER, LANDSBERG, KVERNELAND, NIEMEYER, RABE, OVLAC, KÖCKERLING, FARMET, BEDNAR, ROSS, PHX, UNIA GRUDZIADZ, OPALL AGRI a další.

Balení

Balení v krabicích / ks		Balení bez matic	Balení s maticemi
10 x 25	DIN 608 (4.8, 5.8)	200	150/150
10 x 30	DIN 608 (4.8, 5.8)	150	100/100
10 x 35	DIN 608 (4.8, 5.8)	150	100/100
10 x 40	DIN 608 (4.8, 5.8)	100	100/100
10 x 45	DIN 608 (4.8, 5.8)	100	50/50
10 x 50	DIN 608 (4.8, 5.8)	100	50/50
10 x 55	DIN 608 (4.8, 5.8)	100	50/50
10 x 60	DIN 608 (4.8, 5.8)	150	100/100

10 x 65	DIN 608 (4.8, 5.8)	150	100/100
10 x 70	DIN 608 (4.8, 5.8)	150	100/100
10 x 75	DIN 608 (4.8, 5.8)	100	100/100
10 x 80	DIN 608 (4.8, 5.8)	100	50/50
10 x 90	DIN 608 (4.8, 5.8)	80	50/50
10 x 100	DIN 608 (4.8, 5.8)	80	50/50
12 x 30	DIN 608 (4.8, 5.8)	100	50/50
12 x 35	DIN 608 (4.8, 5.8)	100	50/50
12 x 40	DIN 608 (4.8, 5.8)	150	100/100
12 x 45	DIN 608 (4.8, 5.8)	150	100/100
12 x 50	DIN 608 (4.8, 5.8)	100	100/100
12 x 55	DIN 608 (4.8, 5.8)	100	50/50
12 x 60	DIN 608 (4.8, 5.8)	100	50/50
12 x 65	DIN 608 (4.8, 5.8)	90	50/50
12 x 70	DIN 608 (4.8, 5.8)	80	50/50
12 x 75	DIN 608 (4.8, 5.8)	80	50/50
12 x 80	DIN 608 (4.8, 5.8)	60	50/50
12 x 90	DIN 608 (4.8, 5.8)	50	50/50
12 x 100	DIN 608 (4.8, 5.8)	50	50/50

DIN 608 (8.8)

Pluhové šrouby s čtyřhranem a s maticemi DIN 934 (8.8) zinkované

NEJČASTĚJŠÍ POUŽITÍ

Šrouby do strojů LEMKEN

Nejčastěji používaný kód je OEM Lemken 3015785 12 x 35

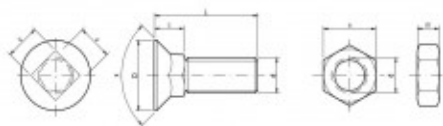

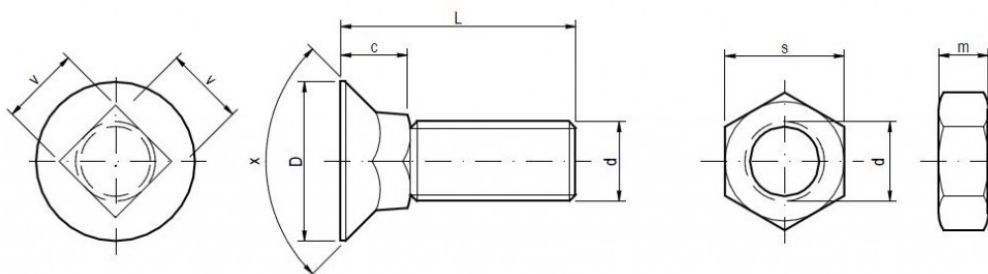

Specifikace

d	c	D	x	v	s	m
M 10	8,00	19,00	90°	10,00	17,00	8,00
M 12	10,50	24,00	90°	12,00	19,00	10,00
M 14	11,00	28,00	90°	14,00	22,00	11,00

Šrouby DIN 608 jsou vhodné do strojů OEM LEMKEN, ÖVERUM, PÖTTINGER, LANDSBERG, KVERNELAND, NIEMEYER, RABE, OVLAC, KÖCKERLING, FARMET, BEDNAR, ROSS, PHX, UNIA GRUDZIADZ, OPALL AGRI a další.

Balení

Balení v krabicích / ks		Balení bez matic	Balení s maticemi
10 x 25	DIN 608 (8.8) zinek	200	150/150
10 x 30	DIN 608 (8.8) zinek	150	100/100
10 x 35	DIN 608 (8.8) zinek	150	100/100
10 x 40	DIN 608 (8.8) zinek	100	100/100
10 x 45	DIN 608 (8.8) zinek	100	50/50
10 x 50	DIN 608 (8.8) zinek	100	50/50
10 x 55	DIN 608 (8.8) zinek	100	50/50
10 x 60	DIN 608 (8.8) zinek	150	100/100

10 x 65	DIN 608 (8.8) zinek	150	100/100
10 x 70	DIN 608 (8.8) zinek	150	100/100
10 x 75	DIN 608 (8.8) zinek	100	100/100
10 x 80	DIN 608 (8.8) zinek	100	50/50
10 x 90	DIN 608 (8.8) zinek	80	50/50
10 x 100	DIN 608 (8.8) zinek	80	50/50
12 x 30	DIN 608 (8.8) zinek	100	50/50
12 x 35	DIN 608 (8.8) zinek	100	50/50
12 x 40	DIN 608 (8.8) zinek	150	100/100
12 x 45	DIN 608 (8.8) zinek	150	100/100
12 x 50	DIN 608 (8.8) zinek	100	100/100
12 x 55	DIN 608 (8.8) zinek	100	50/50
12 x 60	DIN 608 (8.8) zinek	100	50/50
12 x 65	DIN 608 (8.8) zinek	90	50/50
12 x 70	DIN 608 (8.8) zinek	80	50/50
12 x 75	DIN 608 (8.8) zinek	80	50/50
12 x 80	DIN 608 (8.8) zinek	60	50/50
12 x 85	DIN 608 (8.8) zinek	60	50/50
12 x 90	DIN 608 (8.8) zinek	50	50/50
12 x 100	DIN 608 (8.8) zinek	50	50/50
14 x 30	DIN 608 (8.8) zinek	50	50/50
14 x 35	DIN 608 (8.8) zinek	50	50/50
14 x 40	DIN 608 (8.8) zinek	50	50/50
14 x 45	DIN 608 (8.8) zinek	50	50/50
14 x 50	DIN 608 (8.8) zinek	50	50/50
14 x 55	DIN 608 (8.8) zinek	50	50/50
14 x 60	DIN 608 (8.8) zinek	50	50/50
14 x 65	DIN 608 (8.8) zinek	50	50/50
14 x 70	DIN 608 (8.8) zinek	50	50/50
14 x 75	DIN 608 (8.8) zinek	50	50/50
14 x 80	DIN 608 (8.8) zinek	50	50/50

DIN 608 (8.8, 10.9)

Pluhové šrouby se čtyřhranem a s maticemi DIN 934 (8.8)

NEJČASTĚJŠÍ POUŽITÍ

Šrouby do strojů LEMKEN

Nejčastěji používaný kód je OEM LEMKEN 3015785 12 x 35

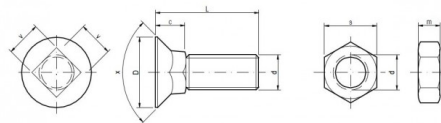

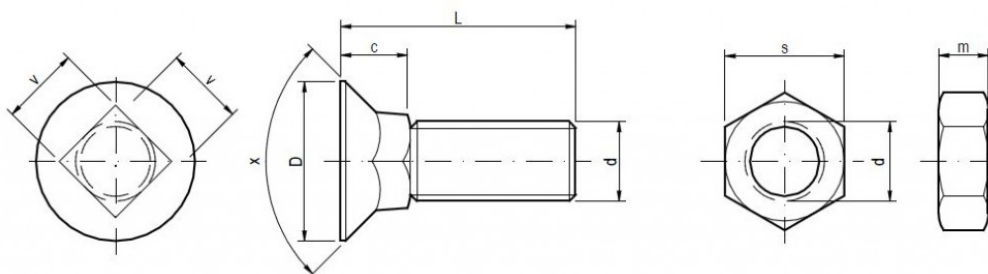
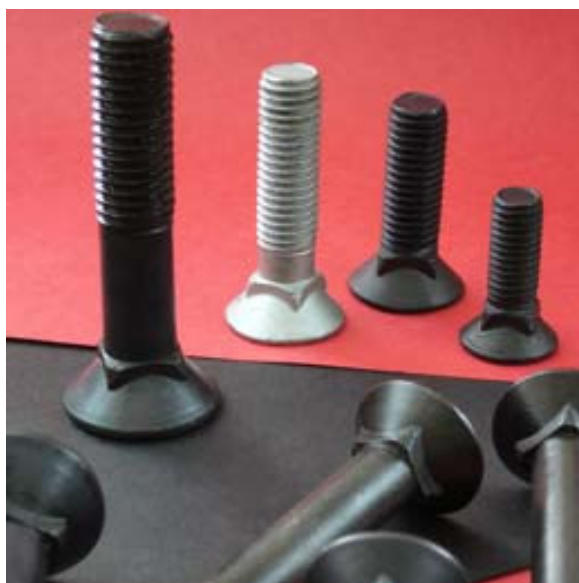

Specifikace

d	c	D	x	v	s	m
M 8	7,00	16,00	90°	8,00	13,00	6,50
M 10	8,00	19,00	90°	10,00	17,00	8,00
M 12	10,50	24,00	90°	12,00	19,00	10,00
M 14	11,00	28,00	90°	14,00	22,00	11,00

Šrouby DIN 608 jsou vhodné do strojů OEM LEMKEN, ÖVERUM, PÖTTINGER, LANDSBERG, KVERNELAND, NIEMEYER, RABE, OVLAC, KÖCKERLING, FARMET, BEDNAR, ROSS, PHX, UNIA GRUDZIADZ, OPALL AGRI a další.

Balení

Balení v krabicích / ks		Balení bez matic	Balení s maticemi
8 x 25	DIN 608 (8.8, 10.9)	250	200/200
8 x 30	DIN 608 (8.8, 10.9)	200	200/200
8 x 35	DIN 608 (8.8, 10.9)	150	100/100
8 x 40	DIN 608 (8.8, 10.9)	150	100/100
8 x 45	DIN 608 (8.8, 10.9)	250	200/200
8 x 50	DIN 608 (8.8, 10.9)	250	200/200
8 x 60	DIN 608 (8.8, 10.9)	200	150/150

8 x 70	DIN 608 (8.8, 10.9)	150	100/100
8 x 80	DIN 608 (8.8, 10.9)	150	100/100
10 x 25	DIN 608 (8.8, 10.9)	200	150/150
10 x 30	DIN 608 (8.8, 10.9)	150	100/100
10 x 35	DIN 608 (8.8, 10.9)	150	100/100
10 x 40	DIN 608 (8.8, 10.9)	100	100/100
10 x 45	DIN 608 (8.8, 10.9)	100	50/50
10 x 50	DIN 608 (8.8, 10.9)	100	50/50
10 x 55	DIN 608 (8.8, 10.9)	100	50/50
10 x 60	DIN 608 (8.8, 10.9)	150	100/100
10 x 65	DIN 608 (8.8, 10.9)	150	100/100
10 x 70	DIN 608 (8.8, 10.9)	150	100/100
10 x 75	DIN 608 (8.8, 10.9)	100	100/100
10 x 80	DIN 608 (8.8, 10.9)	100	50/50
10 x 90	DIN 608 (8.8, 10.9)	80	50/50
10 x 100	DIN 608 (8.8, 10.9)	80	50/50
12 x 30	DIN 608 (8.8, 10.9)	100	50/50
12 x 35	DIN 608 (8.8, 10.9)	100	50/50
12 x 40	DIN 608 (8.8, 10.9)	150	100/100
12 x 45	DIN 608 (8.8, 10.9)	150	100/100
12 x 50	DIN 608 (8.8, 10.9)	100	100/100
12 x 55	DIN 608 (8.8, 10.9)	100	50/50
12 x 60	DIN 608 (8.8, 10.9)	100	50/50
12 x 65	DIN 608 (8.8, 10.9)	90	50/50
12 x 70	DIN 608 (8.8, 10.9)	80	50/50
12 x 75	DIN 608 (8.8, 10.9)	80	50/50
12 x 80	DIN 608 (8.8, 10.9)	60	50/50
12 x 85	DIN 608 (8.8, 10.9)	60	50/50
12 x 90	DIN 608 (8.8, 10.9)	50	50/50
12 x 100	DIN 608 (8.8, 10.9)	50	50/50
14 x 30	DIN 608 (8.8, 10.9)	50	50/50
14 x 35	DIN 608 (8.8, 10.9)	50	50/50
14 x 40	DIN 608 (8.8, 10.9)	50	50/50
14 x 45	DIN 608 (8.8, 10.9)	50	50/50
14 x 50	DIN 608 (8.8, 10.9)	50	50/50
14 x 55	DIN 608 (8.8, 10.9)	50	50/50
14 x 60	DIN 608 (8.8, 10.9)	50	50/50
14 x 65	DIN 608 (8.8, 10.9)	50	50/50
14 x 70	DIN 608 (8.8, 10.9)	50	50/50
14 x 75	DIN 608 (8.8, 10.9)	50	50/50
14 x 80	DIN 608 (8.8, 10.9)	50	50/50

DIN 608 (12.9)

Pluhové šrouby s čtyřhranem a s maticemi DIN 934 (10.9)

NEJČASTĚJŠÍ POUŽITÍ

Šrouby do strojů LEMKEN

Nejčastěji používaný kód je OEM LEMKEN 3015785 12 x 35

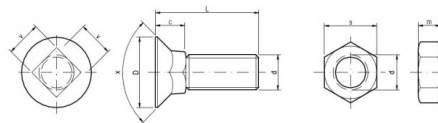

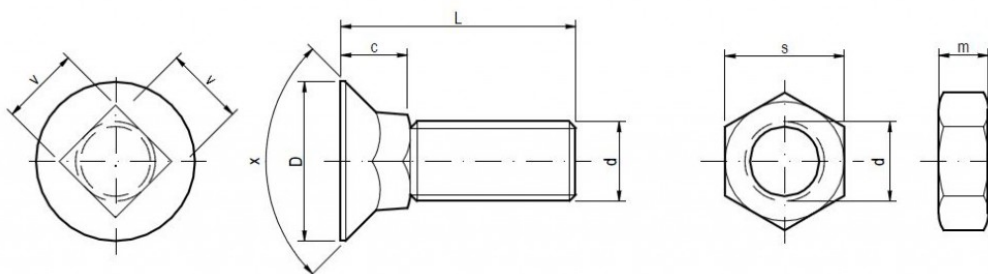

Specifikace

d	c	D	x	v	s	m
M 10	8,00	19,00	90°	10,00	17,00	8,00
M 12	10,50	24,00	90°	12,00	19,00	10,00
M 14	11,00	28,00	90°	14,00	22,00	11,00

Šrouby DIN 608 jsou vhodné do strojů OEM LEMKEN, ÖVERUM, PÖTTINGER, LANDSBERG, KVERNELAND, NIEMEYER, RABE, OVLAC, KÖCKERLING, FARMET, BEDNAR, ROSS, PHX, UNIA GRUDZIADZ, OPALL AGRI a další.

Balení

Balení v krabicích / ks		Balení bez matic	Balení s maticemi
10 x 25	DIN 608 (12.9)	200	150/150
10 x 30	DIN 608 (12.9)	150	100/100
10 x 35	DIN 608 (12.9)	150	100/100
10 x 40	DIN 608 (12.9)	100	100/100
10 x 45	DIN 608 (12.9)	100	50/50
10 x 50	DIN 608 (12.9)	100	50/50
10 x 55	DIN 608 (12.9)	100	50/50
10 x 60	DIN 608 (12.9)	150	100/100
10 x 65	DIN 608 (12.9)	150	100/100
10 x 70	DIN 608 (12.9)	150	100/100

10 x 75	DIN 608 (12.9)	100	100/100
10 x 80	DIN 608 (12.9)	100	50/50
10 x 90	DIN 608 (12.9)	80	50/50
10 x 100	DIN 608 (12.9)	80	50/50
12 x 30	DIN 608 (12.9)	100	50/50
12 x 35	DIN 608 (12.9)	100	50/50
12 x 40	DIN 608 (12.9)	150	100/100
12 x 45	DIN 608 (12.9)	150	100/100
12 x 50	DIN 608 (12.9)	100	100/100
12 x 55	DIN 608 (12.9)	100	50/50
12 x 60	DIN 608 (12.9)	100	50/50
12 x 65	DIN 608 (12.9)	90	50/50
12 x 70	DIN 608 (12.9)	80	50/50
12 x 75	DIN 608 (12.9)	80	50/50
12 x 80	DIN 608 (12.9)	60	50/50
12 x 85	DIN 608 (12.9)	60	50/50
12 x 90	DIN 608 (12.9)	50	50/50
12 x 100	DIN 608 (12.9)	50	50/50
14 x 30	DIN 608 (12.9)	50	50/50
14 x 35	DIN 608 (12.9)	50	50/50
14 x 40	DIN 608 (12.9)	50	50/50
14 x 45	DIN 608 (12.9)	50	50/50
14 x 50	DIN 608 (12.9)	50	50/50
14 x 55	DIN 608 (12.9)	50	50/50
14 x 60	DIN 608 (12.9)	50	50/50
14 x 65	DIN 608 (12.9)	50	50/50
14 x 70	DIN 608 (12.9)	50	50/50
14 x 75	DIN 608 (12.9)	50	50/50
14 x 80	DIN 608 (12.9)	50	50/50

DIN 608 120° (8.8, 10.9)

**Pluhové šrouby se čtyřhranem, 120° hlavou a s maticemi
DIN 934 (8.8)**

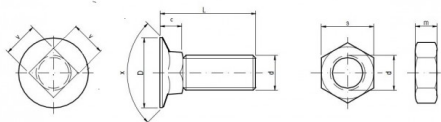

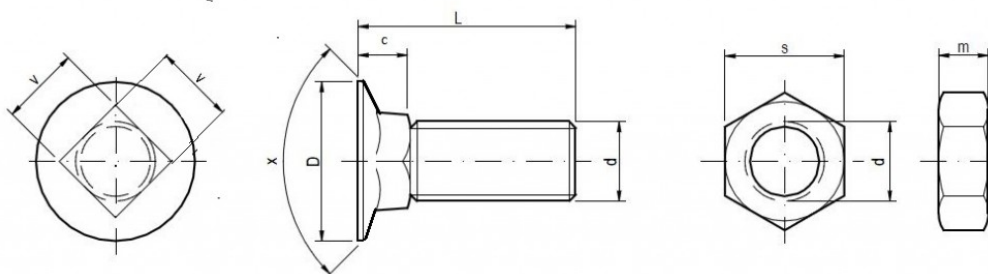

Specifikace

d	c	D	x	v	s	m
M 12	7,00	19,50	120°	12,00	19,00	10,00
M 14	9,60	22,00	120°	14,00	22,00	11,00

Balení

Balení v krabicích		Balení bez matic	Balení s maticemi
12 x 30	DIN 608 120° (8.8, 10.9)	100	100/100
12 x 35	DIN 608 120° (8.8, 10.9)	100	100/100
12 x 40	DIN 608 120° (8.8, 10.9)	150	100/100
12 x 45	DIN 608 120° (8.8, 10.9)	150	100/100
12 x 50	DIN 608 120° (8.8, 10.9)	100	50/50
12 x 55	DIN 608 120° (8.8, 10.9)	100	50/50
12 x 60	DIN 608 120° (8.8, 10.9)	100	50/50
12 x 65	DIN 608 120° (8.8, 10.9)	90	50/50
12 x 70	DIN 608 120° (8.8, 10.9)	80	50/50
12 x 75	DIN 608 120° (8.8, 10.9)	80	50/50
12 x 80	DIN 608 120° (8.8, 10.9)	60	50/50
14 x 30	DIN 608 120° (8.8, 10.9)	50	50/50
14 x 35	DIN 608 120° (8.8, 10.9)	50	50/50
14 x 40	DIN 608 120° (8.8, 10.9)	50	50/50
14 x 45	DIN 608 120° (8.8, 10.9)	50	50/50

14 x 50	DIN 608 120° (8.8, 10.9)	50	50/50
14 x 55	DIN 608 120° (8.8, 10.9)	50	50/50
14 x 60	DIN 608 120° (8.8, 10.9)	50	50/50
14 x 65	DIN 608 120° (8.8, 10.9)	50	50/50
14 x 70	DIN 608 120° (8.8, 10.9)	50	50/50
14 x 75	DIN 608 120° (8.8, 10.9)	50	50/50
14 x 80	DIN 608 120° (8.8, 10.9)	50	50/50

DIN 608 (12.9) KV 3,5

Pluhové šrouby se čtyřhranem a s maticí DIN 934 (10.9)

NEJČASTĚJŠÍ POUŽITÍ

Šrouby **do strojů LEMKEN**

Nejčastěji používaný kód je **OEM LEMKEN 3015721**

M 10 x 33

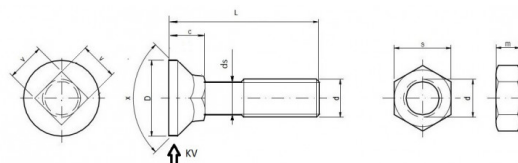

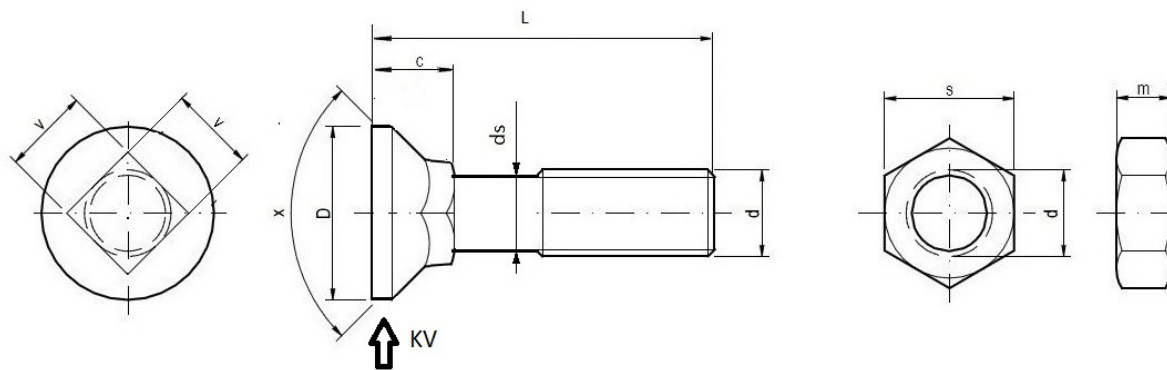

Specifikace

d	c	D	x	v	s	m
M 10 KV 3,5	9,00	19,50	90°	10,00	17,00	8,00

Balení

Balení v krabicích / ks		Balení bez matic	Balení s maticemi
10 x 33	DIN 608 12.9 KV 3,5	150	100/100
10 x 45	DIN 608 12.9 KV 3,5	100	50/50

DIN 608 (12.9) KV 4

Pluhové šrouby se čtyřhranem a s maticí DIN 934 (10.9)

NEJČASTĚJŠÍ POUŽITÍ

Šrouby **do strojů LEMKEN**

Nejčastěji používaný kód je **OEM LEMKEN 3015789**

M 12 x 36

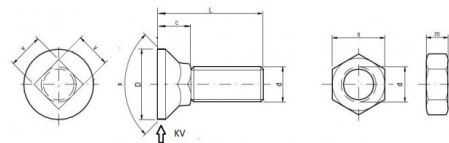

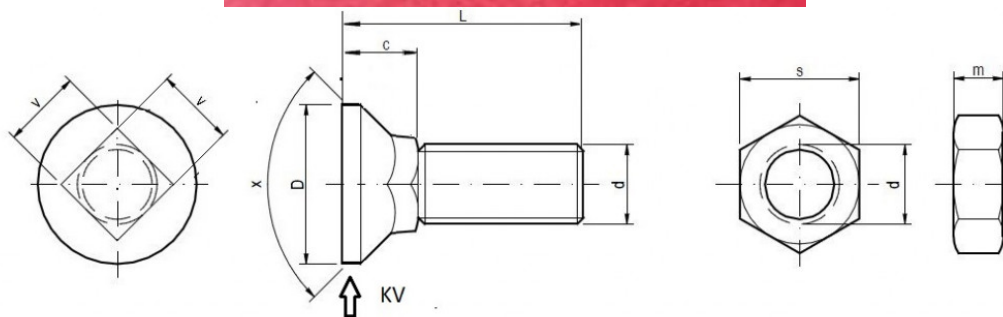

Specifikace

d	c	D	x	v	s	m
M 12 KV 4	10,50	24,00	90°	12,00	19,00	10,00

Balení

Balení v krabicích / ks		Balení bez matic	Balení s maticemi
12 x 36	DIN 608 12.9 KV 4	100	50/50

DIN 11014 (8.8, 10.9)

Pluhové šrouby se dvěma nosy a s maticemi DIN 934 (8.8)

NEJČASTĚJŠÍ POUŽITÍ

Šrouby do strojů VOGEL & NOOT

Nejčastěji používaný šroub je 12 x 35

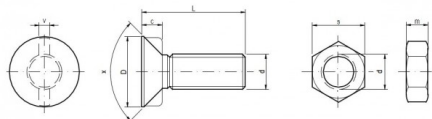

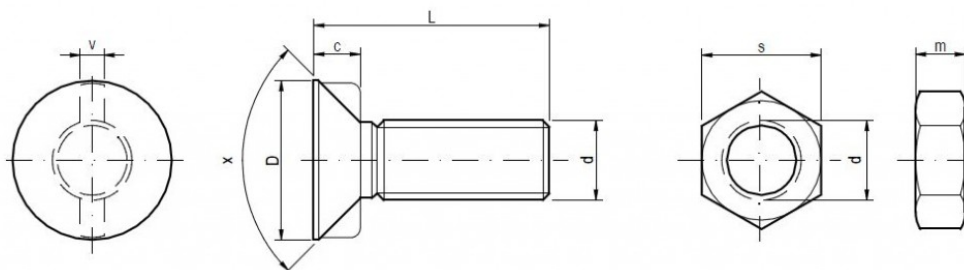

Specifikace

d	c	D	x	v	s	m
M 10	5,50	19,00	90°	3,20	17,00	8,00
M 12	7,50	24,00	90°	3,60	19,00	10,00
M 14	9,50	28,00	90°	4,00	22,00	11,00

Šrouby DIN 11014 jsou vhodné do strojů OEM VOGEL & NOOT, AMAZONE a další.

Balení

Belní v krabicích / ks		Balení bez matic	Balení s maticemi
10 x 25	DIN 11014 (8.8, 10.9)	200	150/150
10 x 30	DIN 11014 (8.8, 10.9)	150	100/100
10 x 35	DIN 11014 (8.8, 10.9)	150	100/100
10 x 40	DIN 11014 (8.8, 10.9)	100	100/100
10 x 45	DIN 11014 (8.8, 10.9)	100	50/50
10 x 50	DIN 11014 (8.8, 10.9)	100	50/50
10 x 55	DIN 11014 (8.8, 10.9)	100	50/50
10 x 60	DIN 11014 (8.8, 10.9)	150	100/100
10 x 70	DIN 11014 (8.8, 10.9)	150	100/100
10 x 80	DIN 11014 (8.8, 10.9)	100	50/50
10 x 90	DIN 11014 (8.8, 10.9)	80	50/50
10 x 100	DIN 11014 (8.8, 10.9)	80	50/50

12 x 30	DIN 11014 (8.8, 10.9)	100	50/50
12 x 35	DIN 11014 (8.8, 10.9)	100	50/50
12 x 40	DIN 11014 (8.8, 10.9)	150	100/100
12 x 45	DIN 11014 (8.8, 10.9)	150	100/100
12 x 50	DIN 11014 (8.8, 10.9)	100	100/100
12 x 55	DIN 11014 (8.8, 10.9)	100	50/50
12 x 60	DIN 11014 (8.8, 10.9)	90	50/50
12 x 65	DIN 11014 (8.8, 10.9)	90	50/50
12 x 70	DIN 11014 (8.8, 10.9)	80	50/50
12 x 75	DIN 11014 (8.8, 10.9)	80	50/50
12 x 80	DIN 11014 (8.8, 10.9)	60	50/50
12 x 85	DIN 11014 (8.8, 10.9)	60	50/50
12 x 90	DIN 11014 (8.8, 10.9)	50	50/50
12 x 100	DIN 11014 (8.8, 10.9)	50	50/50
14 x 35	DIN 11014 (8.8, 10.9)	50	50/50
14 x 40	DIN 11014 (8.8, 10.9)	50	50/50
14 x 45	DIN 11014 (8.8, 10.9)	50	50/50
14 x 50	DIN 11014 (8.8, 10.9)	50	50/50
14 x 60	DIN 11014 (8.8, 10.9)	50	50/50
14 x 70	DIN 11014 (8.8, 10.9)	50	50/50
14 x 80	DIN 11014 (8.8, 10.9)	50	50/50
14 x 90	DIN 11014 (8.8, 10.9)	50	50/50

DIN 11014 (12.9)

Pluhové šrouby s dvěma nosy a s maticemi DIN 934 (10.9)

NEJČASTĚJŠÍ POUŽITÍ

Šrouby do strojů VOGEL & NOOT

Nejčastěji používaný šroub je 12 x 35

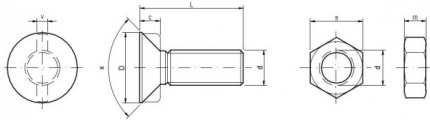

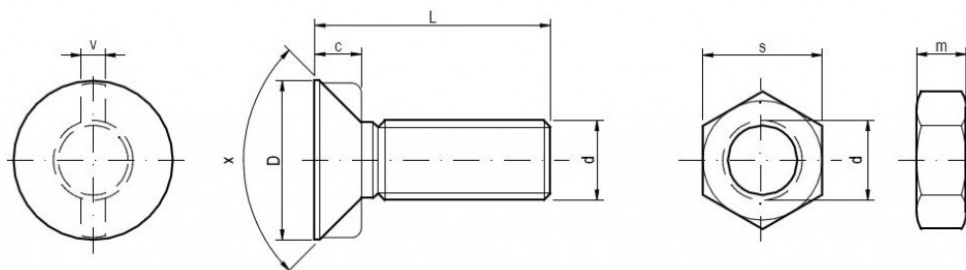

Specifikace

d	c	D	x	v	s	m
M 10	5,50	19,00	90°	3,20	17,00	8,00
M 12	7,50	24,00	90°	3,60	19,00	10,00
M 14	9,50	28,00	90°	4,00	22,00	11,00

Šrouby DIN 11014 vhodné do strojů OEM VOGEL & NOOT, AMAZONE a další.

Balení

Balení v krabicích / ks		Balení bez matic	Balení s maticemi
10 x 25	DIN 11014 (12.9)	200	150/150
10 x 30	DIN 11014 (12.9)	150	100/100
10 x 35	DIN 11014 (12.9)	150	100/100
10 x 40	DIN 11014 (12.9)	100	100/100
10 x 45	DIN 11014 (12.9)	100	50/50
10 x 50	DIN 11014 (12.9)	100	50/50
10 x 55	DIN 11014 (12.9)	100	50/50
10 x 60	DIN 11014 (12.9)	150	100/100
10 x 70	DIN 11014 (12.9)	150	100/100
10 x 80	DIN 11014 (12.9)	100	50/50
10 x 90	DIN 11014 (12.9)	80	50/50
10 x 100	DIN 11014 (12.9)	80	50/50

12 x 30	DIN 11014 (12.9)	100	50/50
12 x 35	DIN 11014 (12.9)	100	50/50
12 x 40	DIN 11014 (12.9)	150	100/100
12 x 45	DIN 11014 (12.9)	150	100/100
12 x 50	DIN 11014 (12.9)	100	100/100
12 x 55	DIN 11014 (12.9)	100	50/50
12 x 60	DIN 11014 (12.9)	90	50/50
12 x 65	DIN 11014 (12.9)	90	50/50
12 x 70	DIN 11014 (12.9)	80	50/50
12 x 75	DIN 11014 (12.9)	80	50/50
12 x 80	DIN 11014 (12.9)	60	50/50
12 x 85	DIN 11014 (12.9)	60	50/50
12 x 90	DIN 11014 (12.9)	50	50/50
12 x 100	DIN 11014 (12.9)	50	50/50
14 x 35	DIN 11014 (12.9)	50	50/50
14 x 40	DIN 11014 (12.9)	50	50/50
14 x 45	DIN 11014 (12.9)	50	50/50
14 x 50	DIN 11014 (12.9)	50	50/50
14 x 60	DIN 11014 (12.9)	50	50/50
14 x 70	DIN 11014 (12.9)	50	50/50
14 x 80	DIN 11014 (12.9)	50	50/50
14 x 90	DIN 11014 (12.9)	50	50/50

DIN 603 - MP (10.9)

**Šrouby s velkou sníženou půlkulovou hlavou a s maticemi
DIN 934 (8.8).**

NEJČASTĚJŠÍ POUŽITÍ

Šrouby do strojů LEMKEN

Nejčastěji používaný kód je OEM LEMKEN 3011805 12 x 30, 12 x 35

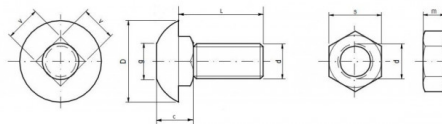

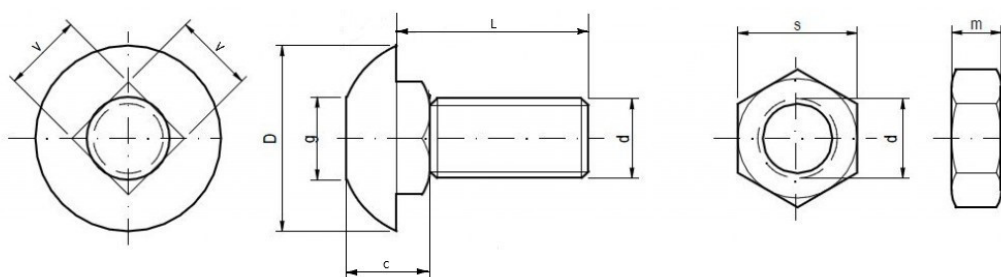
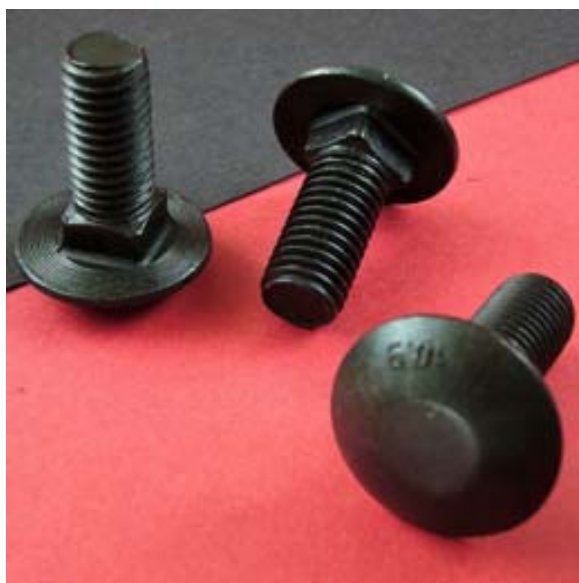

Specifikace

d	c	D	g	v	s	m
M 12	12,50	28,00	12,00	12,00	19,00	10,00

Šrouby DIN 603 MP jsou vhodné do strojů OEM Lemken - RUBIN

Balení

Balení v krabicích / Ks		Balení bez matic	Balení s maticemi
12 x 30	DIN 603 - MP (10.9)	150	100/100
12 x 35	DIN 603 - MP (10.9)	100	100/100

DIN - MP 8677 (10.9)

Šrouby s malou sníženou půlkulovou hlavou a s maticemi
DIN 934 (8.8).

NEJČASTĚJŠÍ POUŽITÍ

Šrouby do strojů LEMKEN

Nejčastěji používaný kód je OEM LEMKEN 3011805 12 x 30, 12 x 35

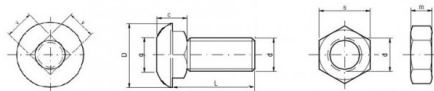

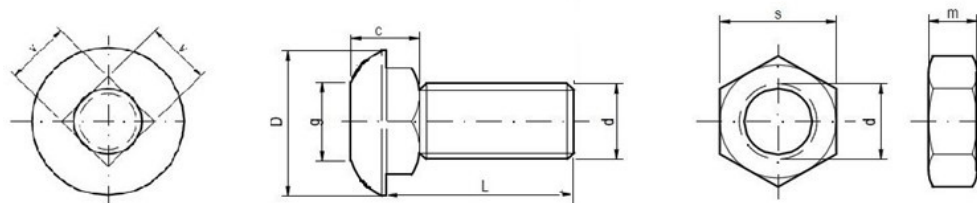

Specifikace

d	c	D	g	v	s	m
M 12	13,00	22,00	13,00	12,00	19,00	10,00

Šrouby DIN - MP 8677 jsou vhodné do strojů OEM LEMKEN - SMARAGD, THORIT, TOPAS

Balení

Balení v krabicích / Ks		Balení bez matic	Balení s maticemi
12 x 30	DIN - MP 8677 (10.9)	150	100/100
12 x 35	DIN - MP 8677 (10.9)	100	100/100

ISO 5713 (8.8, 10.9)

Pluhové šrouby se dvěma nosy a s maticemi DIN 934 (8.8)

NEJČASTĚJŠÍ POUŽITÍ

Šrouby do strojů KVERNELAND

Nejčastěji používaný kód je OEM Kverneland KK033107 12 x 35

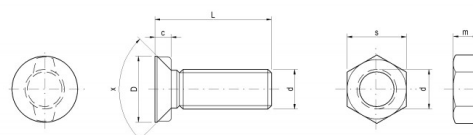

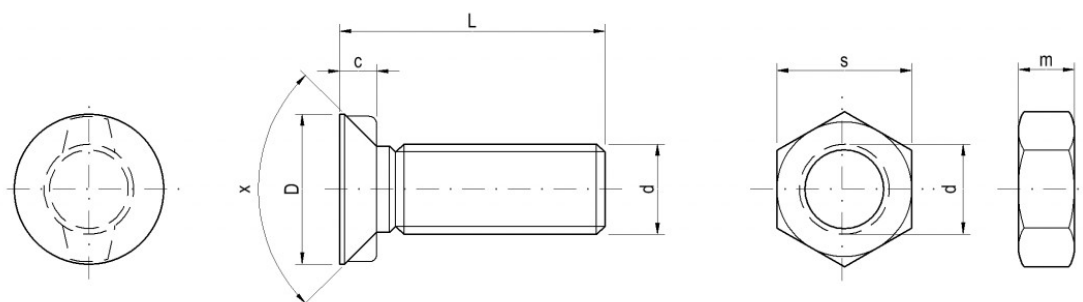

Specifikace

d	c	D	x	s	m
M 10	4,50	16,00	90°	17,00	8,00
M 12	5,50	20,00	90°	19,00	10,00
M 14	7,00	24,00	90°	22,00	11,00

Šrouby ISO 5713 jsou vhodné do strojů OEM KVERNELAND, ÖVERUM, PÖTTINGER, LANDSBERG, NIEMEYER, RABE, OVLAC, KÖCKERLING, FARMET, BEDNAR, ROSS, PHX, UNIA GRUDZIADZ, OPALL AGRI a další

Balení

Balení v krabicích / ks		Balení bez matic	Balení s maticemi
10 x 25	ISO 5713 (8.8, 10.9)	200	150/150
10 x 30	ISO 5713 (8.8, 10.9)	150	100/100
10 x 35	ISO 5713 (8.8, 10.9)	150	100/100
10 x 40	ISO 5713 (8.8, 10.9)	100	100/100
10 x 45	ISO 5713 (8.8, 10.9)	100	50/50
10 x 50	ISO 5713 (8.8, 10.9)	100	50/50
10 x 55	ISO 5713 (8.8, 10.9)	100	50/50
10 x 60	ISO 5713 (8.8, 10.9)	150	100/100
10 x 70	ISO 5713 (8.8, 10.9)	150	100/100

10 x 80	ISO 5713 (8.8, 10.9)	100	50/50
10 x 90	ISO 5713 (8.8, 10.9)	80	50/50
12 x 30	ISO 5713 (8.8, 10.9)	100	50/50
12 x 35	ISO 5713 (8.8, 10.9)	100	50/50
12 x 37	ISO 5713 (8.8, 10.9)	100	50/50
12 x 40	ISO 5713 (8.8, 10.9)	150	100/100
12 x 45	ISO 5713 (8.8, 10.9)	150	100/100
12 x 50	ISO 5713 (8.8, 10.9)	100	100/100
12 x 55	ISO 5713 (8.8, 10.9)	100	50/50
12 x 60	ISO 5713 (8.8, 10.9)	90	50/50
12 x 70	ISO 5713 (8.8, 10.9)	80	50/50
12 x 80	ISO 5713 (8.8, 10.9)	60	50/50
12 x 90	ISO 5713 (8.8, 10.9)	50	50/50
12 x 100	ISO 5713 (8.8, 10.9)	50	50/50
14 x 30	ISO 5713 (8.8, 10.9)	50	50/50
14 x 35	ISO 5713 (8.8, 10.9)	50	50/50
14 x 40	ISO 5713 (8.8, 10.9)	50	50/50
14 x 42	ISO 5713 (8.8, 10.9)	50	50/50
14 x 45	ISO 5713 (8.8, 10.9)	50	50/50
14 x 50	ISO 5713 (8.8, 10.9)	50	50/50
14 x 55	ISO 5713 (8.8, 10.9)	50	50/50
14 x 60	ISO 5713 (8.8, 10.9)	50	50/50
14 x 70	ISO 5713 (8.8, 10.9)	50	50/50
14 x 80	ISO 5713 (8.8, 10.9)	50	50/50

ISO 5713 (12.9)

Pluhové šrouby s dvěma nosy a s maticemi DIN 934 (10.9)

NEJČASTĚJŠÍ POUŽITÍ

Šrouby do strojů KVERNELAND

Nejčastěji používaný kód je OEM Kverneland KK033107 12 x 35

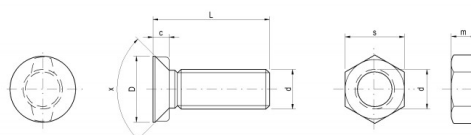

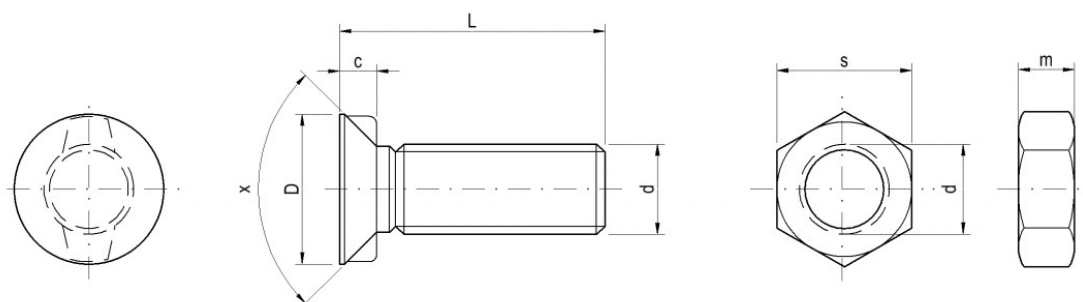

Specifikace

d	c	D	x	s	m
M 10	4,50	16,00	90°	17,00	8,00
M 12	5,50	20,00	90°	19,00	10,00
M 14	7,00	24,00	90°	22,00	11,00

Šrouby ISO 5713 jsou vhodné do strojů OEM KVERNELAND, ÖVERUM, PÖTTINGER, LANDSBERG, NIEMEYER, RABE, OVLAC, KÖCKERLING, FARMET, BEDNAR, ROSS, PHX, UNIA GRUDZIADZ, OPALL AGRI a další.

Balení

Balení v krabicích / ks		Balení bez matic	Balení s maticemi
10 x 25	ISO 5713 (12.9)	200	150/150
10 x 30	ISO 5713 (12.9)	150	100/100
10 x 35	ISO 5713 (12.9)	150	100/100
10 x 40	ISO 5713 (12.9)	100	100/100
10 x 45	ISO 5713 (12.9)	100	50/50
10 x 50	ISO 5713 (12.9)	100	50/50
10 x 55	ISO 5713 (12.9)	100	50/50
10 x 60	ISO 5713 (12.9)	150	100/100
10 x 70	ISO 5713 (12.9)	150	100/100

10 x 80	ISO 5713 (12.9)	100	50/50
12 x 30	ISO 5713 (12.9)	100	50/50
12 x 35	ISO 5713 (12.9)	100	50/50
12 x 37	ISO 5713 (12.9)	100	50/50
12 x 40	ISO 5713 (12.9)	150	100/100
12 x 45	ISO 5713 (12.9)	150	100/100
12 x 50	ISO 5713 (12.9)	100	100/100
12 x 55	ISO 5713 (12.9)	100	50/50
12 x 60	ISO 5713 (12.9)	90	50/50
12 x 70	ISO 5713 (12.9)	80	50/50
12 x 80	ISO 5713 (12.9)	60	50/50
12 x 90	ISO 5713 (12.9)	50	50/50
12 x 100	ISO 5713 (12.9)	50	50/50
14 x 30	ISO 5713 (12.9)	50	50/50
14 x 35	ISO 5713 (12.9)	50	50/50
14 x 40	ISO 5713 (12.9)	50	50/50
14 x 42	ISO 5713 (12.9)	50	50/50
14 x 45	ISO 5713 (12.9)	50	50/50
14 x 50	ISO 5713 (12.9)	50	50/50
14 x 55	ISO 5713 (12.9)	50	50/50
14 x 60	ISO 5713 (12.9)	50	50/50
14 x 70	ISO 5713 (12.9)	50	50/50
14 x 80	ISO 5713 (12.9)	50	50/50

ISO 5713 (8.8, 10.9) KV 1,3

Pluhové šrouby s dvěma nosy a s maticemi DIN 934 (8.8)

NEJČASTĚJŠÍ POUŽITÍ

Šrouby do strojů KVERNELAND

Nejčastěji používaný šroub je KVERNELAND 12 x 35

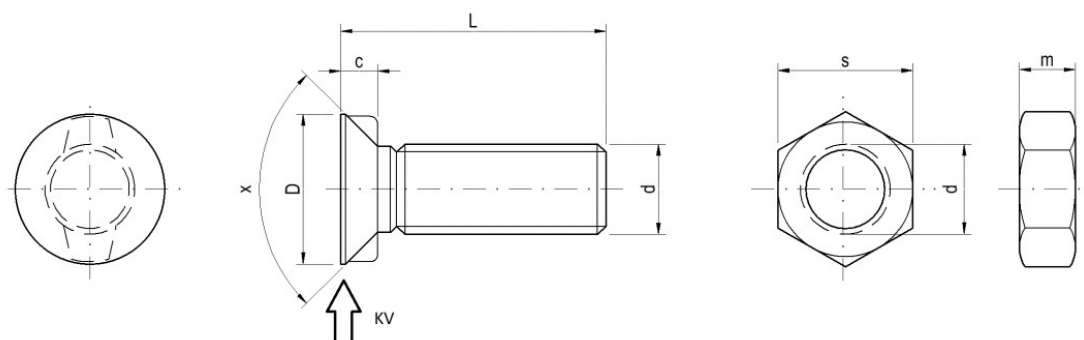
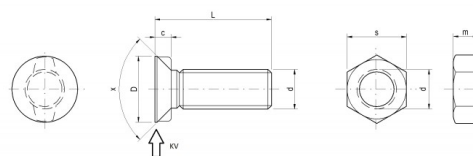

Specifikace

d	c	D	x	s	m
M 12 KV 1,3	5,00	20,00	90°	19,00	10,00

Šrouby ISO 5713 jsou vhodné do strojů OEM KVERNELAND, ÖVERUM, PÖTTINGER, LANDSBERG, NIEMEYER, RABE, OVLAC, KÖCKERLING, FARMET, BEDNAR, ROSS, PHX, UNIA GRUDZIADZ, OPALL AGRI a další.

Balení

Balení v krabicích / ks		Balení bez matic	Balení s maticemi
12 x 30	ISO 5713 (8.8,10.9) KV 1,3	100	50/50
12 x 35	ISO 5713 (8.8,10.9) KV 1,3	100	50/50
12 x 40	ISO 5713 (8.8,10.9) KV 1,3	150	100/100
12 x 45	ISO 5713 (8.8,10.9) KV 1,3	150	100/100
12 x 50	ISO 5713 (8.8,10.9) KV 1,3	100	100/100
12 x 60	ISO 5713 (8.8,10.9) KV 1,3	90	50/50
12 x 70	ISO 5713 (8.8,10.9) KV 1,3	80	50/50
12 x 80	ISO 5713 (8.8,10.9) KV 1,3	60	50/50
12 x 90	ISO 5713 (8.8,10.9) KV 1,3	50	50/50
12 x 100	ISO 5713 (8.8,10.9) KV 1,3	50	50/50

ISO 5713 (12.9) KV 1,3

Pluhové šrouby se dvěma nosy a s maticemi DIN 934 (10.9)

NEJČASTĚJŠÍ POUŽITÍ

Šrouby do strojů KVERNELAND

Nejčastěji používaný šroub je KVERNELAND 12 x 35

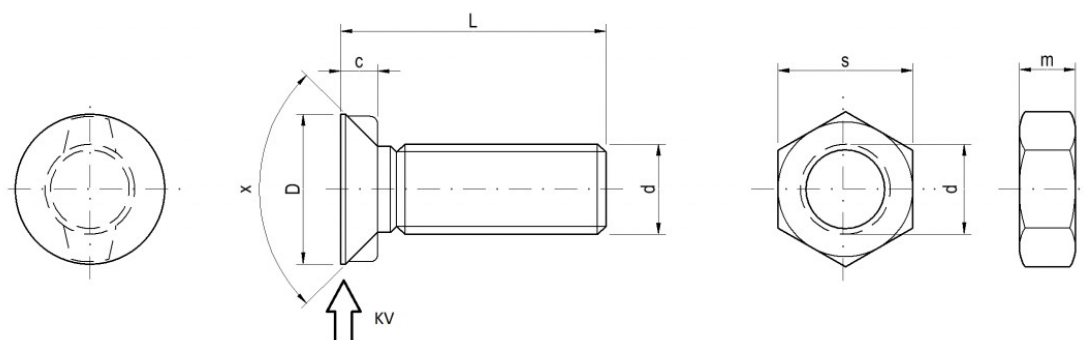
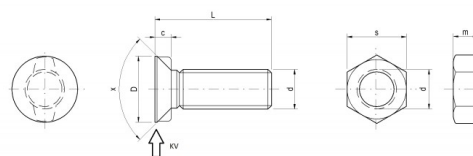

Specifikace

d	c	D	x	s	m
M 12 KV 1,3	5,00	20,00	90°	19,00	10,00

Šrouby ISO 5713 jsou vhodné do strojů OEM KVERNELAND, ÖVERUM, PÖTTINGER, LANDSBERG, NIEMEYER, RABE, OVLAC, KÖCKERLING, FARMET, BEDNAR, ROSS, PHX, UNIA GRUDZIADZ, OPALL AGRI a další.

Balení

Balení v krabicích / ks		Balení bez matice	Balení s maticemi
12 x 30	ISO 5713 (12.9) KV 1,3	100	50/50
12 x 35	ISO 5713 (12.9) KV 1,3	100	50/50
12 x 40	ISO 5713 (12.9) KV 1,3	150	100/100
12 x 45	ISO 5713 (12.9) KV 1,3	150	100/100
12 x 50	ISO 5713 (12.9) KV 1,3	100	100/100
12 x 60	ISO 5713 (12.9) KV 1,3	90	50/50
12 x 70	ISO 5713 (12.9) KV 1,3	80	50/50
12 x 80	ISO 5713 (12.9) KV 1,3	60	50/50
12 x 90	ISO 5713 (12.9) KV 1,3	50	50/50
12 x 100	ISO 5713 (12.9) KV 1,3	50	50/50

ISO 5713 (8.8, 10.9) KV 1,8

Pluhové šrouby se dvěma nosy a s maticemi DIN 934 (8.8)

NEJČASTĚJŠÍ POUŽITÍ

Šrouby do strojů KVERNELAND

Nejčastěji používaný šroub je KVERNELAND 12 x 35

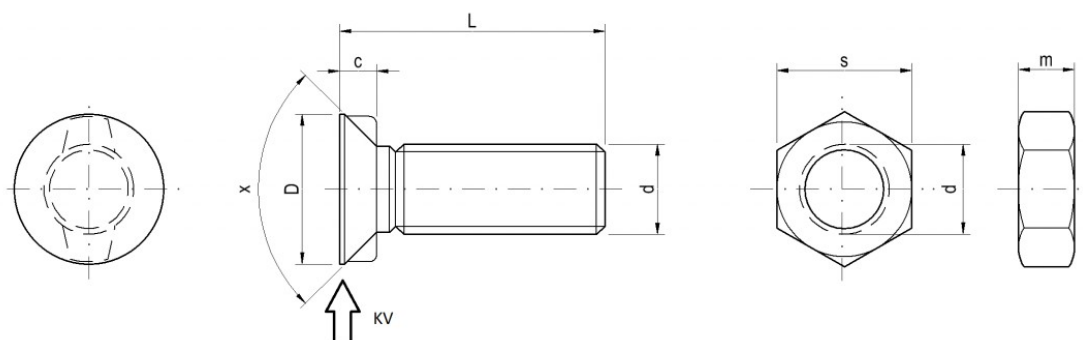
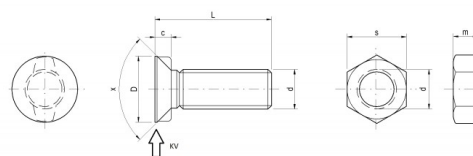

Specifikace

d	c	D	x	s	m
M 14 KV 1,8	6,80	24,00	90°	22,00	11,00

Šrouby ISO 5713 jsou vhodné do strojů OEM KVERNELAND, ÖVERUM, PÖTTINGER, LANDSBERG, NIEMEYER, RABE, OVLAC, KÖCKERLING, FARMET, BEDNAR, ROSS, PHX, UNIA GRUDZIADZ, OPALL AGRI a další.

Balení

Balení v krabicích / ks		Balení bez matice	Balení s maticemi
14 x 30	ISO 5713 (8.8,10.9) KV 1,8	50	50/50
14 x 35	ISO 5713 (8.8,10.9) KV 1,8	50	50/50
14 x 40	ISO 5713 (8.8,10.9) KV 1,8	50	50/50
14 x 45	ISO 5713 (8.8,10.9) KV 1,8	50	50/50
14 x 50	ISO 5713 (8.8,10.9) KV 1,8	50	50/50
14 x 60	ISO 5713 (8.8,10.9) KV 1,8	50	50/50
14 x 70	ISO 5713 (8.8,10.9) KV 1,8	50	50/50
14 x 80	ISO 5713 (8.8,10.9) KV 1,8	50	50/50

ISO 5713 (12.9) KV 1,8

Pluhové šrouby se dvěma nosy a s maticemi DIN 934 (10.9)

NEJČASTĚJŠÍ POUŽITÍ

Šrouby do strojů KVERNELAND

Nejčastěji používaný šroub je KVERNELAND 12 x 35

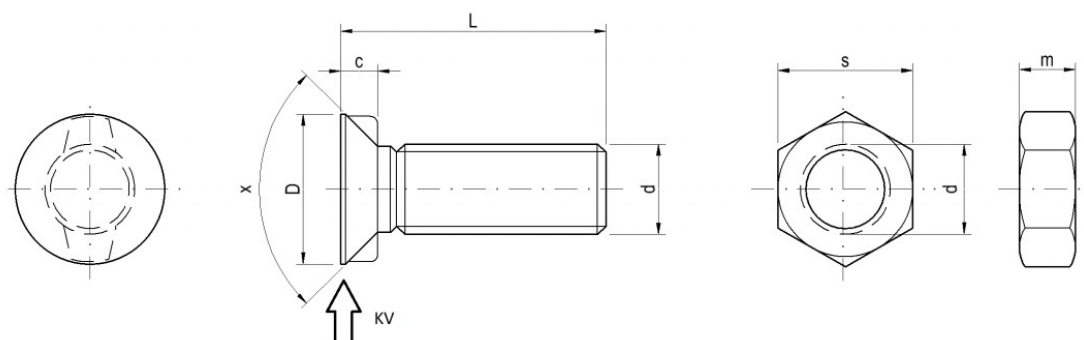
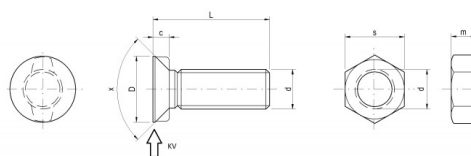

Specifikace

d	c	D	x	s	m
M 14 KV 1,8	6,80	24,00	90°	22,00	11,00

Šrouby ISO 5713 jsou vhodné do strojů OEM KVERNELAND, ÖVERUM, PÖTTINGER, LANDSBERG, NIEMEYER, RABE, OVLAC, KÖCKERLING, FARMET, BEDNAR, ROSS, PHX, UNIA GRUDZIADZ, OPALL AGRI a další.

Balení

Balení v krabicích / ks		Balení bez matic	Balení s maticemi
14 x 30	ISO 5713 (12.9) KV 1,8	50	50/50
14 x 35	ISO 5713 (12.9) KV 1,8	50	50/50
14 x 40	ISO 5713 (12.9) KV 1,8	50	50/50
14 x 45	ISO 5713 (12.9) KV 1,8	50	50/50
14 x 50	ISO 5713 (12.9) KV 1,8	50	50/50
14 x 60	ISO 5713 (12.9) KV 1,8	50	50/50
14 x 70	ISO 5713 (12.9) KV 1,8	50	50/50
14 x 80	ISO 5713 (12.9) KV 1,8	50	50/50

ISO 5713 (8.8, 10.9) KV 4,0

Pluhové šrouby se dvěma nosy a s maticemi DIN 934 (8.8)

NEJČASTĚJŠÍ POUŽITÍ

Šrouby do strojů KVERNELAND

Nejčastěji používaný šroub je KVERNELAND 12 x 35

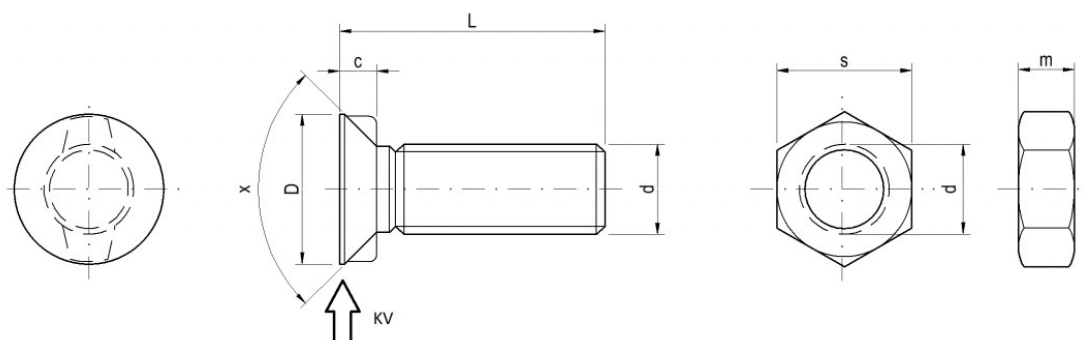
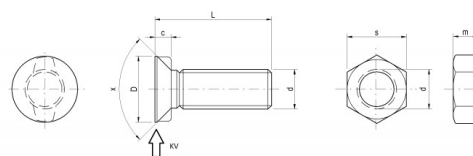

Specifikace

d	c	D	x	s	m
M 12 KV 4,0	8,00	20,00	90°	19,00	10,00

Šrouby ISO 5713 jsou vhodné do strojů OEM KVERNELAND, ÖVERUM, PÖTTINGER, LANDSBERG, NIEMEYER, RABE, OVLAC, KÖCKERLING, FARMET, BEDNAR, ROSS, PHX, UNIA GRUDZIADZ, OPALL AGRI a další.

Balení

Balení v krabicích / ks		Balení bez matic	Balení s maticemi
12 x 30	ISO 5713 (8.8,10.9) KV 4	100	50/50
12 x 35	ISO 5713 (8.8,10.9) KV 4	100	50/50
12 x 40	ISO 5713 (8.8,10.9) KV 4	150	100/100
12 x 45	ISO 5713 (8.8,10.9) KV 4	150	100/100
12 x 50	ISO 5713 (8.8,10.9) KV 4	100	100/100
12 x 60	ISO 5713 (8.8,10.9) KV 4	90	50/50
12 x 70	ISO 5713 (8.8,10.9) KV 4	80	50/50
12 x 80	ISO 5713 (8.8,10.9) KV 4	60	50/50
12 x 90	ISO 5713 (8.8,10.9) KV 4	50	50/50
12 x 100	ISO 5713 (8.8,10.9) KV 4	50	50/50

ISO 5713 (12.9) KV 4,0

Pluhové šrouby se dvěma nosy a s maticemi DIN 934 (10.9)

NEJČASTĚJŠÍ POUŽITÍ

Šrouby do strojů KVERNELAND

Nejčastěji používaný šroub je KVERNELAND 12 x 35

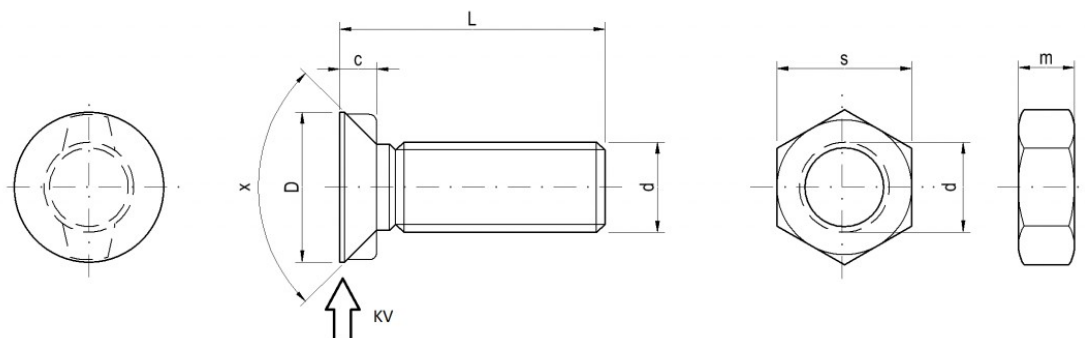
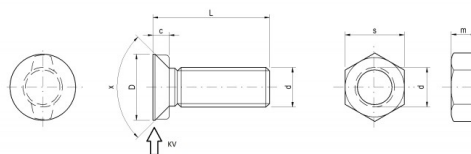

Specifikace

d	c	D	x	s	m
M 12 KV 4,0	8,00	20,00	90°	19,00	10,00

Šrouby ISO 5713 jsou vhodné do strojů OEM KVERNELAND, ÖVERUM, PÖTTINGER, LANDSBERG, NIEMEYER, RABE, OVLAC, KÖCKERLING, FARMET, BEDNAR, ROSS, PHX, UNIA GRUDZIADZ, OPALL AGRI a další.

Balení

Balení v krabicích / ks		Balení bez matic	Balení s maticemi
12 x 30	ISO 5713 (12.9) KV 4	100	50/50
12 x 35	ISO 5713 (12.9) KV 4	100	50/50
12 x 40	ISO 5713 (12.9) KV 4	150	100/100
12 x 45	ISO 5713 (12.9) KV 4	150	100/100
12 x 50	ISO 5713 (12.9) KV 4	100	100/100
12 x 60	ISO 5713 (12.9) KV 4	90	50/50
12 x 70	ISO 5713 (12.9) KV 4	80	50/50
12 x 80	ISO 5713 (12.9) KV 4	60	50/50
12 x 90	ISO 5713 (12.9) KV 4	50	50/50
12 x 100	ISO 5713 (12.9) KV 4	50	50/50

ISO 5713 BH - BIG HEAD (12.9)

Pluhové šrouby se dvěma nosy a s maticemi DIN 934 (10.9)

NEJČASTĚJŠÍ POUŽITÍ

Šrouby do strojů KVERNELAND

Nejčastěji používaný šroub je Kverneland 10 x 35.

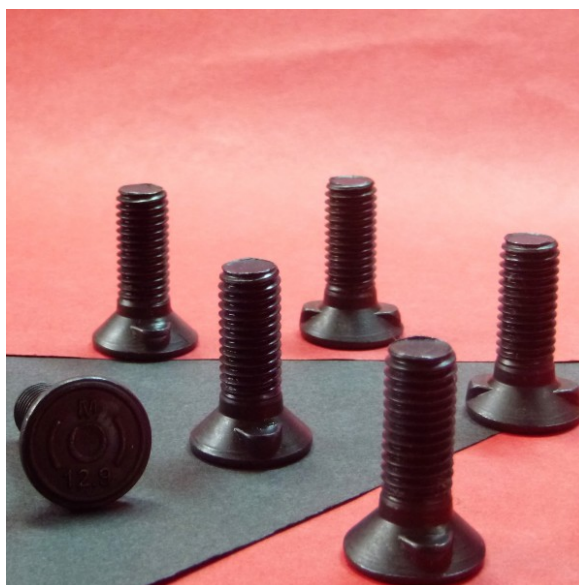
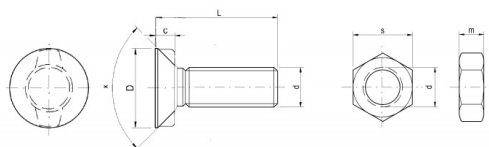

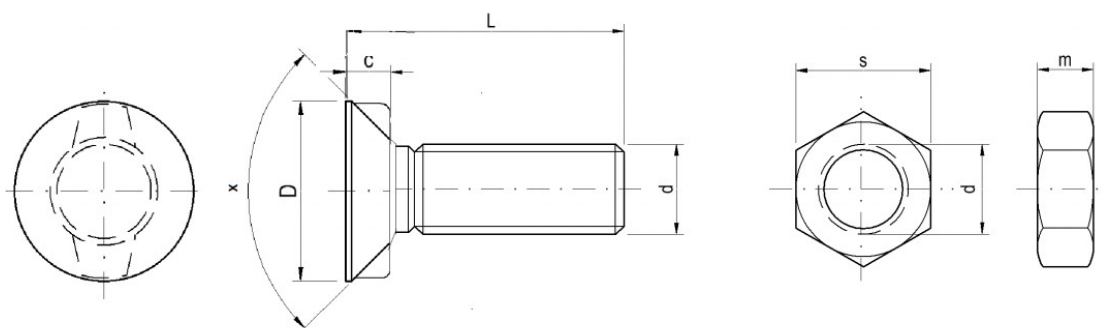

Specifikace

d	c	D	x	s	m
M 10	6,50	20,00	90°	17,00	8,00

Šrouby ISO 5713 jsou vhodné do strojů OEM KVERNELAND.

Balení

Balení v krabicích / ks		Balení bez matic	Balení s maticemi
10 x 25	ISO 5713 BH (12.9)	200	150/150
10 x 30	ISO 5713 BH (12.9)	150	100/100
10 x 35	ISO 5713 BH (12.9)	150	100/100
10 x 40	ISO 5713 BH (12.9)	100	100/100
10 x 45	ISO 5713 BH (12.9)	100	50/50
10 x 50	ISO 5713 BH (12.9)	100	50/50
10 x 60	ISO 5713 BH (12.9)	150	100/100
10 x 70	ISO 5713 BH (12.9)	150	100/100
10 x 80	ISO 5713 BH (12.9)	100	50/50

MP - 1 (10.9, 12.9)

Pluhové šrouby s konickou hlavou a s maticemi DIN 934 (8.8, 10.9)

NEJČASTĚJŠÍ POUŽITÍ

Šrouby do strojů KVERNELAND

Nejčastěji používaný kód je OEM Kverneland KK0133333 14 x 34

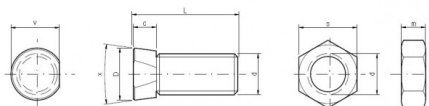

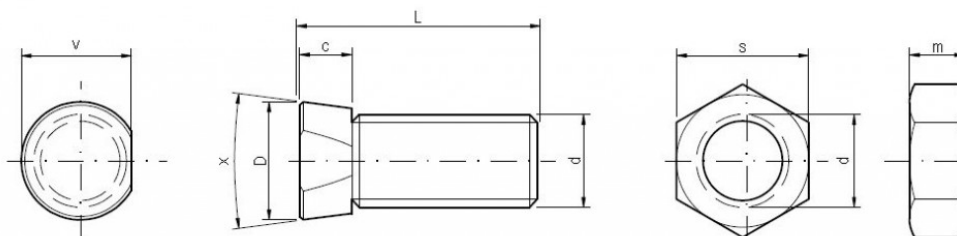

Specifikace

d	c	D	x	v	s	m
M14	7,00	18,00	15°	17,00	22,00	11,00

Šrouby MP - 1 jsou vhodné do strojů OEM KVERNELAND, ÖVERUM, PÖTTINGER, LEMKEN, NIEMEYER, RABE, OVLAC, KÖCKERLING, FARMET, BEDNAR, ROSS, PHX, UNIA GRUDZIADZ, OPALLI AGRI, LANDSBERG a další.

Balení

Balení v krabicích / ks		Balení bez matic	Balení s maticemi
14 x 30	MP - 1 (10.9,12.9)	100	50/50
14 x 34	MP - 1 (10.9,12.9)	100	50/50
14 x 35	MP - 1 (10.9,12.9)	100	50/50
14 x 37	MP - 1 (10.9,12.9)	100	50/50
14 x 38	MP - 1 (10.9,12.9)	100	50/50
14 x 40	MP - 1 (10.9,12.9)	50	50/50
14 x 42	MP - 1 (10.9,12.9)	50	50/50
14 x 44	MP - 1 (10.9,12.9)	50	50/50
14 x 45	MP - 1 (10.9,12.9)	50	50/50
14 x 50	MP - 1 (10.9,12.9)	50	50/50
14 x 60	MP - 1 (10.9,12.9)	50	50/50
14 x 70	MP - 1 (10.9,12.9)	50	50/50

14 x 80	MP - 1 (10.9,12.9)	50	50/50
---------	--------------------	----	-------

MP - 2 (10.9, 12.9)

Pluhové šrouby s konickou hlavou a s maticemi DIN 934 (8.8, 10.9)

NEJČASTĚJŠÍ POUŽITÍ

Šrouby do strojů KVERNELAND

Nejčastěji používaný kód je OEM Kverneland KK013228 M12 x 34, KK013234 M12 x 38

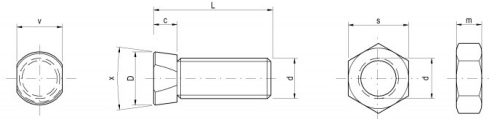

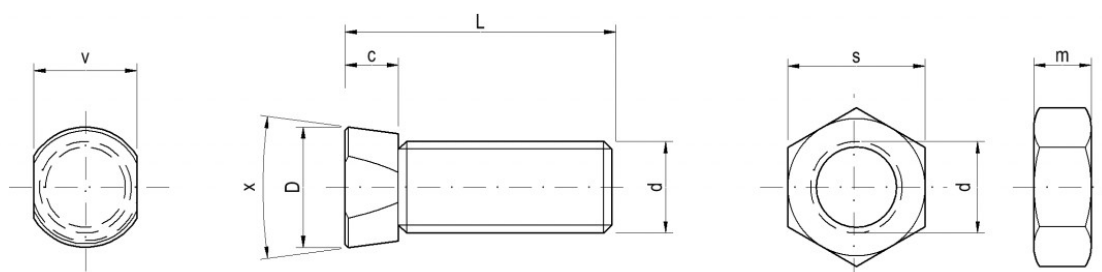

Specifikace

d	c	D	x	v	s	m
M 10	7,00	15,90	15°	13,50	17,00	8,00
M 12	7,00	15,90	15°	13,50	19,00	10,00

Šrouby MP - 2 jsou vhodné do strojů OEM KVERNELAND, ÖVERUM, PÖTTINGER, LANDSBERG, LEMKEN, NIEMEYER, RABE, OVLAC, KÖCKERLING, FARMET, BEDNAR, ROSS PHX, UNIA GRUDZIADZ, OPALL AGRI a další.

Balení

Balení v krabicích / ks		Balení bez matic	Balení s maticemi
10 x 25	MP - 2 (10.9, 12.9)	100	100/100
10 x 30	MP - 2 (10.9, 12.9)	100	100/100
10 x 35	MP - 2 (10.9, 12.9)	100	100/100
10 x 40	MP - 2 (10.9, 12.9)	100	100/100
12 x 30	MP - 2 (10.9, 12.9)	150	100/100
12 x 33	MP - 2 (10.9, 12.9)	150	100/100
12 x 34	MP - 2 (10.9, 12.9)	150	100/100
12 x 35	MP - 2 (10.9, 12.9)	150	100/100
12 x 37	MP - 2 (10.9, 12.9)	100	50/50

12 x 38	MP - 2 (10.9, 12.9)	100	50/50
12 x 40	MP - 2 (10.9, 12.9)	100	50/50
12 x 42	MP - 2 (10.9, 12.9)	100	50/50
12 x 45	MP - 2 (10.9, 12.9)	100	50/50
12 x 50	MP - 2 (10.9, 12.9)	100	50/50
12 x 55	MP - 2 (10.9, 12.9)	50	50/50
12 x 60	MP - 2 (10.9, 12.9)	50	50/50
12 x 70	MP - 2 (10.9, 12.9)	50	50/50
12 x 80	MP - 2 (10.9, 12.9)	50	50/50
12 x 90	MP - 2 (10.9, 12.9)	50	50/50
12 x 100	MP - 2 (10.9, 12.9)	50	50/50

MP - 2 - 30° (12.9)

Šrouby s konickou hlavou 30° a s maticemi DIN 934 (10.9)

NEJČASTĚJŠÍ POUŽITÍ

Šrouby do strojů VOGEL & NOOT

Nejčastěji používaný šroub je 12 x 40

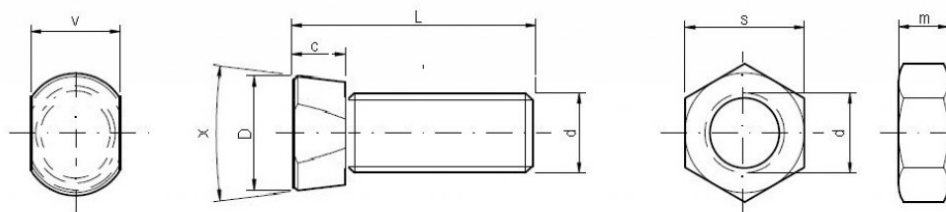
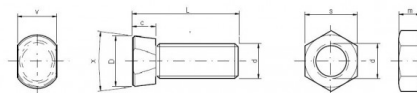

Specifikace

d	c	D	x	v	s	m
M 12	9,00	17,50	30°	13,30	19,00	10,00
M 14	9,00	18,50	30°	14,20	22,00	11,00

Šrouby MP - 2 30° jsou vhodné do strojů OEM VOGEL&NOOT, AMAZONE a další

Balení

Balení v krabicích / ks		Balení bez matic	Balení s maticemi
12 x 30	MP - 2 30° (12.9)	150	100/100
12 x 33	MP - 2 30° (12.9)	150	100/100
12 x 34	MP - 2 30° (12.9)	150	100/100
12 x 35	MP - 2 30° (12.9)	150	100/100
12 x 37	MP - 2 30° (12.9)	100	50/50
12 x 38	MP - 2 30° (12.9)	100	50/50
12 x 40	MP - 2 30° (12.9)	100	50/50
12 x 42	MP - 2 30° (12.9)	100	50/50
12 x 45	MP - 2 30° (12.9)	100	50/50
12 x 50	MP - 2 30° (12.9)	100	50/50
12 x 55	MP - 2 30° (12.9)	50	50/50
12 x 60	MP - 2 30° (12.9)	50	50/50
12 x 70	MP - 2 30° (12.9)	50	50/50
12 x 80	MP - 2 30° (12.9)	50	50/50
12 x 90	MP - 2 30° (12.9)	50	50/50
12 x 100	MP - 2 30° (12.9)	50	50/50
14 x 34	MP - 2 30° (12.9)	100	50/50
14 x 39	MP - 2 30° (12.9)	100	50/50
14 x 40	MP - 2 30° (12.9)	50	50/50
14 x 45	MP - 2 30° (12.9)	50	50/50
14 x 50	MP - 2 30° (12.9)	50	50/50
14 x 60	MP - 2 30° (12.9)	50	50/50

MP - 2 G (12.9)

Pluhové šrouby s konickou hlavou a s maticemi DIN 934 (10.9)

NEJČASTĚJŠÍ POUŽITÍ

Šrouby do strojů KVERNELAND

Nejčastěji používaný šroub je 12 x 36

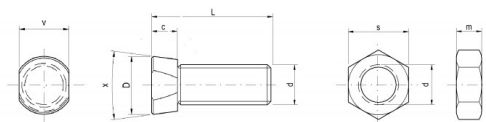

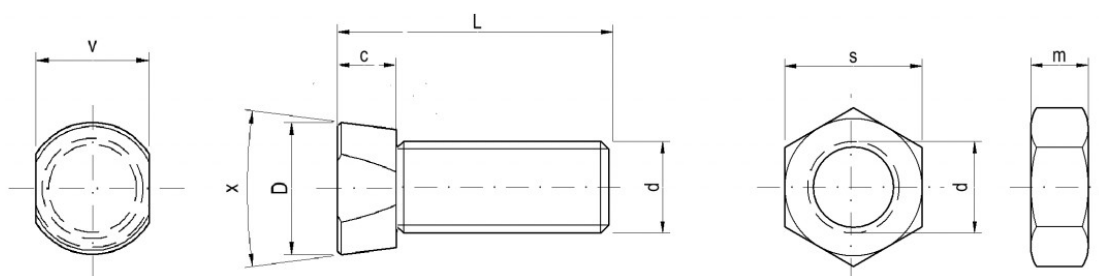

Specifikace

d	c	D	x	v	s	m
M 12	8,00	16,00	20°	13,40	19,00	10,00

Šrouby MP - 2 G jsou vhodné do strojů OEM KVERNELAND, ÖVERUM, PÖTTINGER LANDSBERG, LEMKEN, NIEMEYER, RABE, OVLAC, KÖCKERLING, FARMET, BEDNAR, ROSS, PHX, UNIA GRUDZIADZ, OPALL AGRI a další.

Balení

Balení v krabicích / ks		Balení bez matic	Balení s maticemi
12 x 36	MP - 2 G 12.9	100	50/50

MP - 2 IT (12.9)

Pluhové šrouby s konickou hlavou a s maticemi DIN 934 (10.9)

NEJČASTĚJŠÍ POUŽITÍ

Šrouby do strojů KVERNELAND

Nejčastěji používaný šroub je 12 x 37

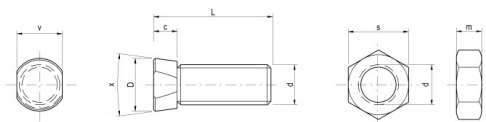

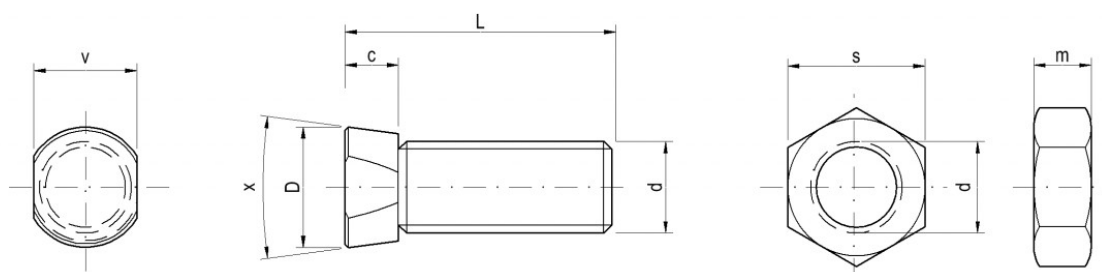

Specifikace

d	c	D	x	v	s	m
M 12	7,00	16,00	10°	14,00	19,00	10,00

Šrouby MP - 2 G jsou vhodné do strojů OEM KVERNELAND, ÖVERUM, PÖTTINGER LANDSBERG, LEMKEN, NIEMEYER, RABE, OVLAC, KÖCKERLING, FARMET, BEDNAR, ROSS, PHX, UNIA GRUDZIADZ, OPALL AGRI a další.

Balení

Balení v krabicích / ks		Balení bez matic	Balení s maticemi
12 x 37	MP - 2 IT 12.9	100	50/50

MP - 3 IHC (10.9, 12.9)

Pluhové šrouby s konickou hlavou a s maticemi DIN 934 (8.8, 10.9)

NEJČASTĚJŠÍ POUŽITÍ

Šrouby do strojů GREGORIE BESSON

Nejčastěji používaný šroub je 12 x 35

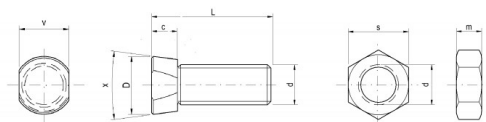

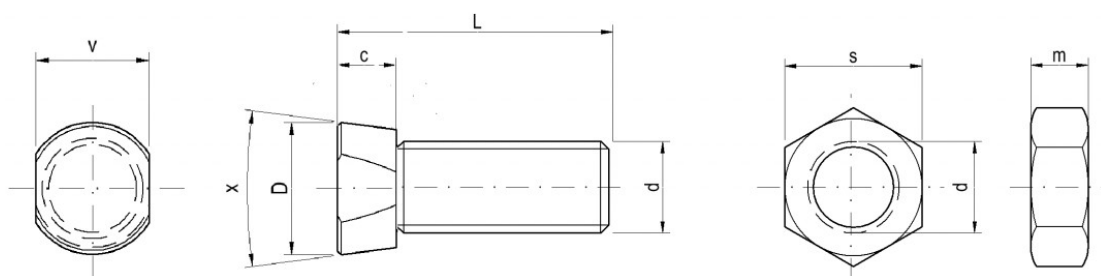

Specifikace

d	c	D	x	v	s	m
M 12	8,00	17,50	15°	14,70	19,00	10,00

Šrouby MP - 3 IHC jsou vhodné do strojů GREGORIE BESSON, OEM KVERNELAND, ÖVERUM, PÖTTINGER, LANDSBERG, LEMKEN, NIEMEYER, RABE, OVLAC, KÖCKERLING, FARMET, BEDNAR, ROSS, PHX, UNIA GRUDZIADZ, OPALL AGRI a další.

Balení

Balení v krabicích / ks		Balení bez matic	Balení s maticemi
12 x 35	MP - 3 IHC (10.9)	150	100/100
12 x 40	MP - 3 IHC (10.9)	100	50/50
12 x 45	MP - 3 IHC (10.9)	100	50/50
12 x 35	MP - 3 IHC (12.9)	150	100/100
12 x 40	MP - 3 IHC (12.9)	100	50/50
12 x 45	MP - 3 IHC (12.9)	100	50/50

MP - 4 (4.8, 5.8)

Pluhové šrouby s konickou hlavou a čtyřhranem a s maticemi DIN 934 (8.8)

NEJČASTĚJŠÍ POUŽITÍ

Šrouby pro kultivátory

Nejčastěji používané šrouby jsou 10 x 35, 10 x 40, 10 x 60

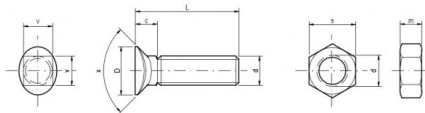

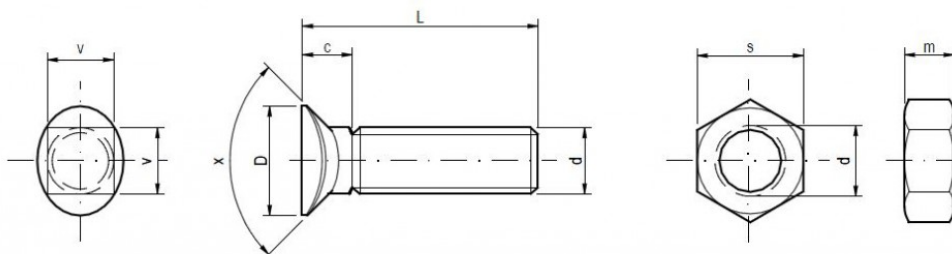

Specifikace

d	c	D	x	v	s	m
M 10	8,00	16,5/15,5	90°	10,00	17,00	8,00
M 12	9,50	22/19,5	90°	12,00	19,00	10,00

Šrouby MP - 4 jsou vhodné do strojů OEM LEMKEN, ÖVERUM, PÖTTINGER, LANDSBERG, KVERNELAND, NIEMEYER, RABE, OVLAC, KÖCKERLING, FARMET, BEDNAR, ROSS, PHX, UNIA GRUDZIADZ, OPALL AGRI, KONGSKILDE a další.

Balení

Balení v krabicích / ks		Balení bez matic	Balení s maticemi
10 x 30	MP - 4 (4.8, 5.8)	150	100/100
10 x 35	MP - 4 (4.8, 5.8)	150	100/100
10 x 37	MP - 4 (4.8, 5.8)	100	100/100
10 x 40	MP - 4 (4.8, 5.8)	100	100/100
10 x 45	MP - 4 (4.8, 5.8)	100	50/50
10 x 50	MP - 4 (4.8, 5.8)	100	50/50
10 x 55	MP - 4 (4.8, 5.8)	100	50/50
10 x 60	MP - 4 (4.8, 5.8)	150	100/100
12 x 35	MP - 4 (4.8, 5.8)	100	50/50
12 x 37	MP - 4 (4.8, 5.8)	100	50/50

12 x 40	MP - 4 (4.8, 5.8)	150	100/100
12 x 45	MP - 4 (4.8, 5.8)	150	100/100
12 x 48	MP - 4 (4.8, 5.8)	150	100/100
12 x 50	MP - 4 (4.8, 5.8)	100	100/100
12 x 55	MP - 4 (4.8, 5.8)	100	50/50
12 x 60	MP - 4 (4.8, 5.8)	90	50/50
12 x 70	MP - 4 (4.8, 5.8)	80	50/50
12 x 80	MP - 4 (4.8, 5.8)	60	50/50
12 x 90	MP - 4 (4.8, 5.8)	50	50/50
12 x 100	MP - 4 (4.8, 5.8)	50	50/50

MP - 4 (8.8, 10.9, 12.9)

Pluhové šrouby s konickou hlavou a čtyřhranem a s maticemi DIN 934 (8.8, 10.9)

NEJČASTĚJŠÍ POUŽITÍ

Šrouby pro kultivátory

Nejčastěji používané šrouby jsou 10 x 35, 10 x 40, 10 x 60

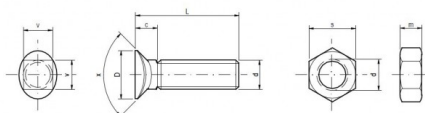

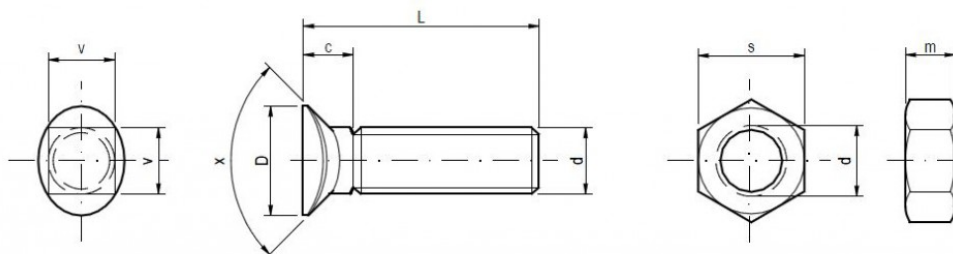

Specifikace

d	c	D	x	v	s	m
M 10	8,00	16,5/15,5	90°	10,00	17,00	8,00
M 12	9,50	22/19,5	90°	12,00	19,00	10,00

Šrouby MP - 4 jsou vhodné do strojů OEM LEMKEN, ÖVERUM, PÖTTINGER, LANDSBERG, KVERNELAND, NIEMEYER, RABE, OVLAC, KÖCKERLING, FARMET, BEDNAR, ROSS, PHX, UNIA GRUDZIADZ, OPALL AGRI, KONGSKILDE a další.

Balení

Balení v krabicích / ks		Balení bez matic	Balení s maticemi
10 x 30	MP - 4 (8.8,10.9,12.9)	150	100/100
10 x 35	MP - 4 (8.8,10.9,12.9)	150	100/100
10 x 37	MP - 4 (8.8,10.9,12.9)	100	100/100
10 x 40	MP - 4 (8.8,10.9,12.9)	100	100/100
10 x 42	MP - 4 (8.8,10.9,12.9)	100	100/100
10 x 44	MP - 4 (8.8,10.9,12.9)	100	50/50
10 x 45	MP - 4 (8.8,10.9,12.9)	100	50/50
10 x 50	MP - 4 (8.8,10.9,12.9)	100	50/50
10 x 55	MP - 4 (8.8,10.9,12.9)	100	50/50
10 x 60	MP - 4 (8.8,10.9,12.9)	150	100/100
10 x 70	MP - 4 (8.8,10.9,12.9)	150	100/100

10 x 80	MP - 4 (8.8,10.9,12.9)	100	50/50
10 x 90	MP - 4 (8.8,10.9,12.9)	80	50/50
10 x 100	MP - 4 (8.8,10.9,12.9)	80	50/50
12 x 35	MP - 4 (8.8,10.9,12.9)	100	50/50
12 x 37	MP - 4 (8.8,10.9,12.9)	100	50/50
12 x 40	MP - 4 (8.8,10.9,12.9)	150	100/100
12 x 45	MP - 4 (8.8,10.9,12.9)	150	100/100
12 x 48	MP - 4 (8.8,10.9,12.9)	150	100/100
12 x 50	MP - 4 (8.8,10.9,12.9)	100	100/100
12 x 55	MP - 4 (8.8,10.9,12.9)	100	50/50
12 x 60	MP - 4 (8.8,10.9,12.9)	90	50/50
12 x 70	MP - 4 (8.8,10.9,12.9)	80	50/50
12 x 80	MP - 4 (8.8,10.9,12.9)	60	50/50
12 x 90	MP - 4 (8.8,10.9,12.9)	50	50/50
12 x 100	MP - 4 (8.8,10.9,12.9)	50	50/50

MP - 4 K (8.8 , 10.9, 12.9)

Pluhové šrouby s konickou hlavou a čtyřhranem a s maticemi DIN 934 (8.8, 10.9)

NEJČASTĚJŠÍ POUŽITÍ

Šrouby pro kultivátory

Nejčastěji používané šrouby jsou 10 x 35, 10 x 40, 10 x 60

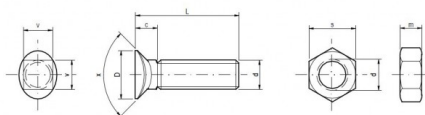

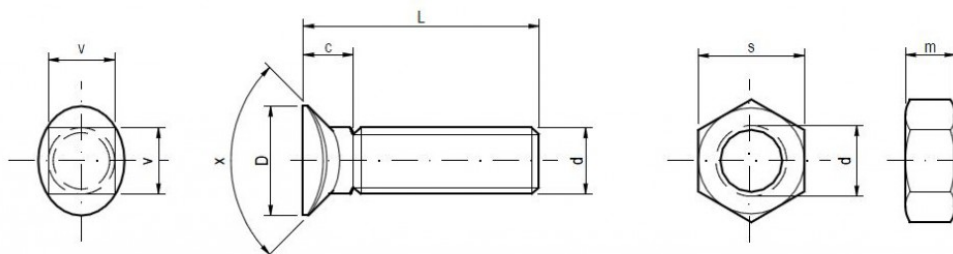

Specifikace

d	c	D	x	v	s	m
M 10	7,60	18,00/16,00	90°	10,00	17,00	8,00

Šrouby MP - 4 K jsou vhodné do strojů OEM LEMKEN, ÖVERUM, PÖTTINGER, LANDSBERG, KVERNELAND, NIEMEYER, RABE, OVLAC, KÖCKERLING, FARMET, BEDNAR, ROSS, PHX, UNIA GRUDZIADZ, OPALL AGRI, KONGSKILDE a další.

Balení

Balení v krabicích / ks		Balení bez matic	Balení s maticemi
10 x 30	MP - 4 K (8.8,10.9,12.9)	150	100/100
10 x 35	MP - 4 K (8.8,10.9,12.9)	150	100/100
10 x 37	MP - 4 K (8.8,10.9,12.9)	100	100/100
10 x 40	MP - 4 K (8.8,10.9,12.9)	100	100/100
10 x 45	MP - 4 K (8.8,10.9,12.9)	100	50/50
10 x 50	MP - 4 K (8.8,10.9,12.9)	100	50/50
10 x 55	MP - 4 K (8.8,10.9,12.9)	100	50/50
10 x 60	MP - 4 K (8.8,10.9,12.9)	150	100/100
10 x 70	MP - 4 K (8.8,10.9,12.9)	150	100/100
10 x 80	MP - 4 K (8.8,10.9,12.9)	100	50/50
10 x 90	MP - 4 K (8.8,10.9,12.9)	80	50/50
10 x 100	MP - 4 K (8.8,10.9,12.9)	80	50/50

MOLBRO (10.9, 12.9)

Pluhové šrouby s konickou hlavou a s maticemi DIN 934 (8.8, 10.9)

NEJČASTĚJŠÍ POUŽITÍ

Šrouby do strojů MÖLBRO

Nejčastěji používaný šroub je M12 x 34 MÖLBRO

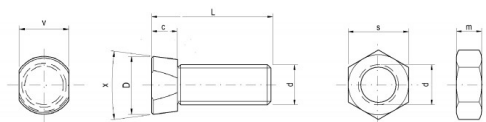

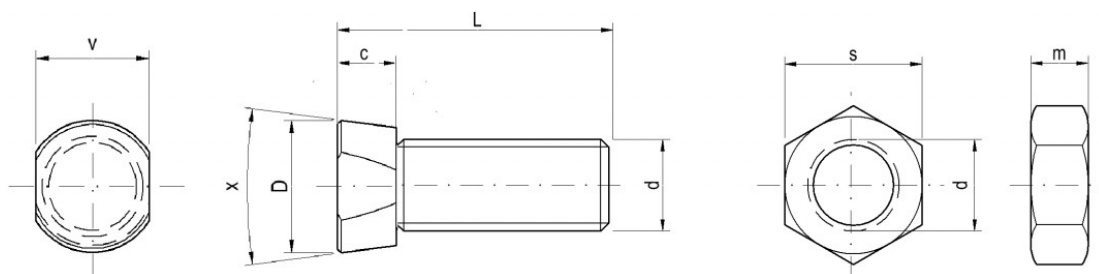

Specifikace

d	c	D	x	v	s	m
M 12	9,30	16,70	15°	13,70	19,00	10,00

Šrouby MÖLBRO jsou vhodné do strojů OEM MÖLBRO, KVERNELAND, ÖVERUM, PÖTTINGER, LANDSBERG, NIEMEYER, RABE OVAL, KÖCKERLING, FARMET, BEDNAR ROSS, PHX, UNIA GRUDZIADZ, OPALL AGRI a další.

Balení

Baleno v krabicích / ks		Balení bez matic	Balení s maticemi
12 x 34	MOLBRO (10.9, 12.9)	150	100/100

MP - 5 (10.9, 12.9)

Pluhové šrouby s konickou hlavou s jednou ploškou a s maticemi DIN 934 (8.8,10.9).

NEJČASTĚJŠÍ POUŽITÍ

Šrouby do strojů PÖTTINGER

Nejčastěji používané šrouby jsou 14 x 36, 14 x 38

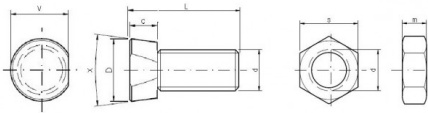

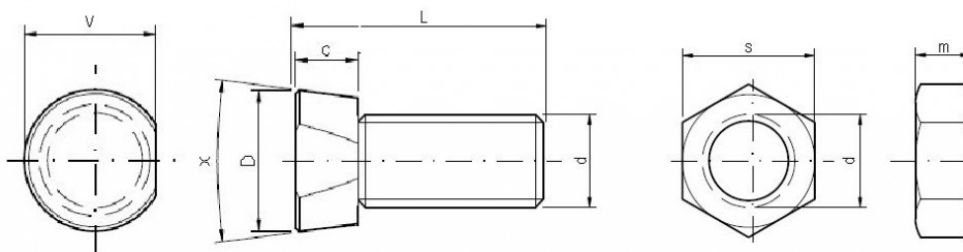

Specifikace

d	c	D	x	v	s	m
M14	9,70	18,50	15°	16,80	22,00	11,00

Šrouby MP - 5 jsou vhodné do strojů PÖTTINGER

Balení

Balení v krabicích / ks		Balení bez matic	Balení s maticemi
14 x 36	MP - 5 (10.9)	100	50/50
14 x 38	MP - 5 (10.9)	100	50/50
14 x 36	MP - 5 (12.9)	100	50/50
14 x 38	MP - 5 (12.9)	100	50/50

MP - T (8.8, 10.9)

Pluhové šrouby s konickou čtvercovou hlavou a s maticemi DIN 934 (8.8).

NEJČASTĚJŠÍ POUŽITÍ

Šrouby do strojů ÜNLÜ

Nejčastěji používaný šroub je 12 x 40

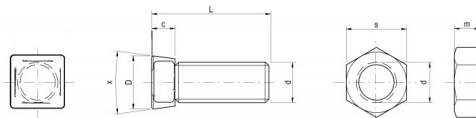

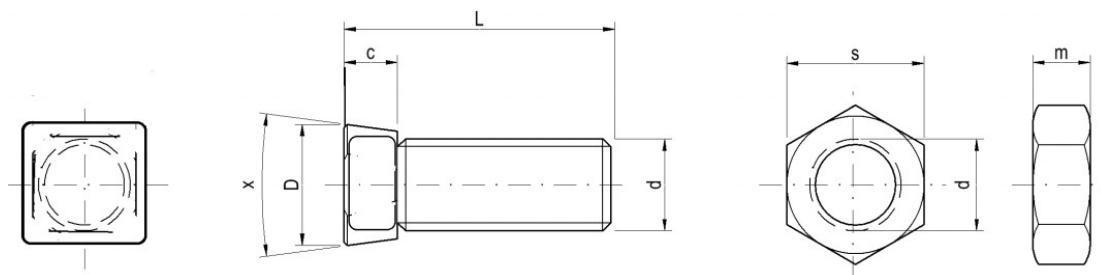

Specifikace

d	c	D	x	s	m
M 12	6,50	15,00 x 15,00	30°	19,00	10,00

Šrouby MP - T jsou vhodné do strojů OEM ÜNLÜ.

Balení

Balení v krabicích / ks		Balení bez matic	Balení s maticemi
12 x 30	MP - T (8.8, 10.9)	150	100/100
12 x 32	MP - T (8.8, 10.9)	150	100/100
12 x 35	MP - T (8.8, 10.9)	150	100/100
12 x 38	MP - T (8.8, 10.9)	100	50/50
12 x 40	MP - T (8.8, 10.9)	100	50/50
12 x 45	MP - T (8.8, 10.9)	100	50/50
12 x 50	MP - T (8.8, 10.9)	100	50/50

MP - 21 (10.9)

Šrouby s velkou půlkulovou hlavou s nosem a s maticemi DIN 934 (8.8)

NEJČASTĚJŠÍ POUŽITÍ

Šrouby pro směšovače s vlastním pohonem

Nejčastěji používaný šroub je 12 x 42

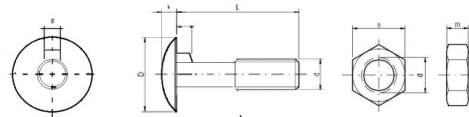

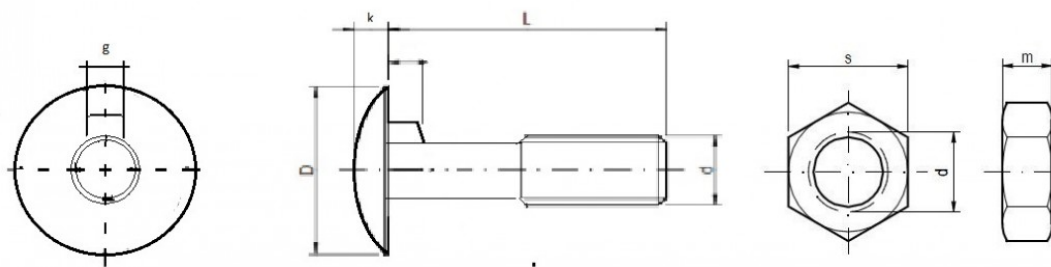

Specifikace

d	c	D	g	k	s	m
M 12	4,75	24,00	6,80	5,30	19,00	10,00

Šrouby MP - 21 jsou vhodné do strojů OEM STORTI,FARESIN a další

Balení

Balení v krabicích / ks		Balení bez matic	Balení s maticemi
12 x 42	MP - 21 (10.9)	100	100/100

NIEMEYER 1232 N (10.9, 12.9)

Pluhové šrouby s konickou hlavou a s maticemi DIN 934 (8.8, 10.9)

NEJČASTĚJŠÍ POUŽITÍ

Šrouby pro NIEMEYER

Nejčastěji používaný šroub je 12 x 32

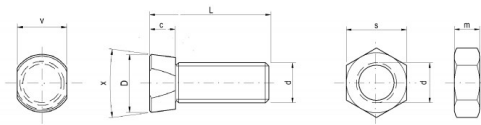

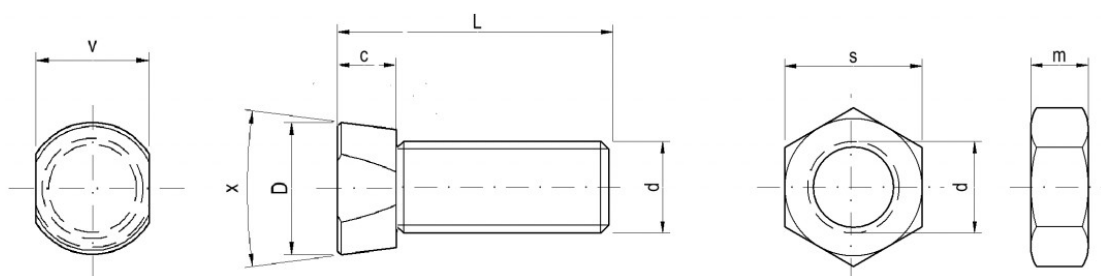

Specifikace

d	c	D	x	v	s	m
M 12	8,70	18,00	15°	13,60	19,00	10,00

Šrouby NIEMEYER jsou vhodné do strojů OEM NIEMEYER

Balení

Balení v krabicích / ks		Balení bez matic	Balení s maticemi
12 x 32	Niemeyer 1232N (10.9,12.9)	150	100/100

RABE OVAL (10.9, 12.9)

Pluhové šrouby s konickou hlavou a s maticemi DIN 934 (8.8, 10.9)

NEJČASTĚJŠÍ POUŽITÍ

Šrouby pro RABE

Nejčastěji používaný šroub je 12 x 35

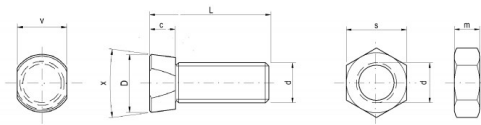

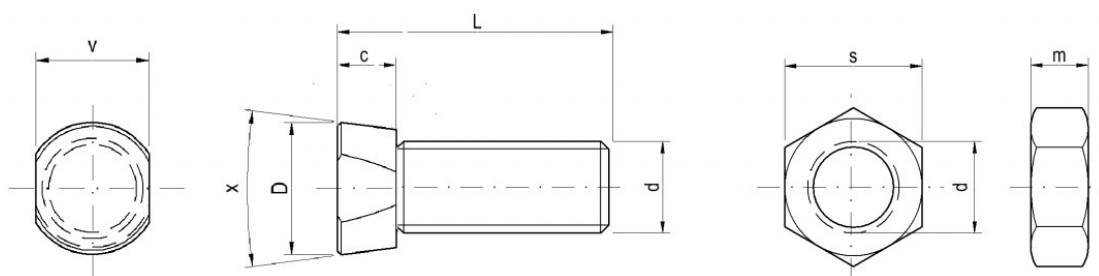

Specifikace

d	c	D	x	v	s	m
M 12	8,50	18,00	10°	14,00	19,00	10,00

Šrouby RABE OVAL jsou vhodné do strojů OEM RABE

Balení

Balení v krabicích / ks		Balení bez matic	Balení s maticemi
12 x 35	RABE OVAL (10.9, 12.9)	100	100/100
12 x 40	RABE OVAL (10.9, 12.9)	100	50/50
12 x 45	RABE OVAL (10.9, 12.9)	100	50/50

RABE OVAL K (10.9, 12.9)

Pluhové šrouby s konickou hlavou a s maticemi DIN 934 (8.8, 10.9)

NEJČASTĚJŠÍ POUŽITÍ

Šrouby pro RABE

Nejčastěji používaný šroub je 12 x 35

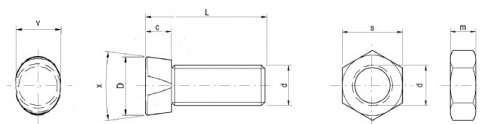

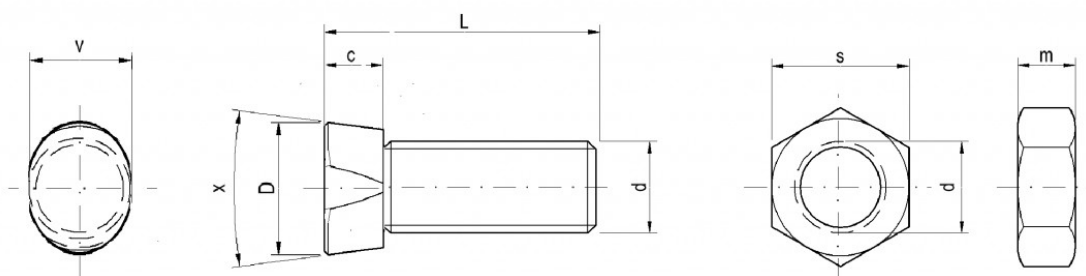

Specifikace

d	c	D	x	v	s	m
M 12	8,50	18,00	10°	14,00	19,00	10,00

Šrouby RABE OVAL jsou vhodné do strojů OEM RABE

Balení

Balení v krabicích / ks		Balení bez matic	Balení s maticemi
12 x 30	Rabe Oval K (10.9, 12.9)	150	100/100
12 x 35	Rabe Oval K (10.9, 12.9)	150	100/100
12 x 37	Rabe Oval K (10.9, 12.9)	100	50/50
12 x 40	Rabe Oval K (10.9, 12.9)	100	50/50
12 x 45	Rabe Oval K (10.9, 12.9)	100	50/50

UNI 6104 (8.8, 10.9)

Pluhové šrouby se čtyřhranem a s maticí DIN 934 (8.8)

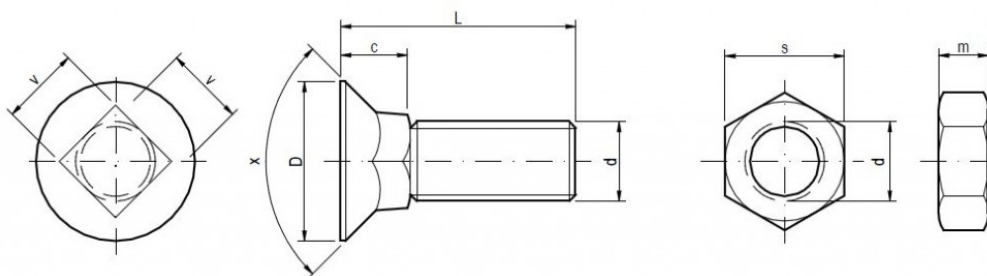
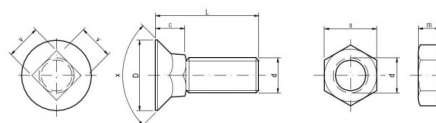

Specifikace

d	c	D	x	v	s	m
M 12	12,00	24,00	90° + 5°	12,00	19,00	10,00
M 14	14,00	28,00	90° + 5°	14,00	22,00	11,00

Balení

	Balení bez matic	Balení s maticemi
	bez matic	s maticemi
UNI 6104 (8.8, 10.9)	100	50/50
UNI 6104 (8.8, 10.9)	150	100/100
UNI 6104 (8.8, 10.9)	100	100/100
UNI 6104 (8.8, 10.9)	90	50/50
UNI 6104 (8.8, 10.9)	80	50/50
UNI 6104 (8.8, 10.9)	60	50/50
UNI 6104 (8.8, 10.9)	50	50/50
UNI 6104 (8.8, 10.9)	50	50/50
UNI 6104 (8.8, 10.9)	50	50/50
UNI 6104 (8.8, 10.9)	50	50/50
UNI 6104 (8.8, 10.9)	50	50/50
UNI 6104 (8.8, 10.9)	50	50/50
UNI 6104 (8.8, 10.9)	50	50/50

UNI 6104 (12.9)

Pluhové šrouby se čtyřhranem a s maticí DIN 934 (10.9)

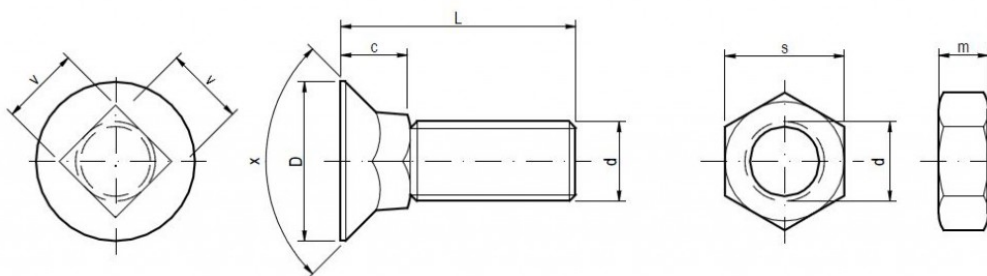
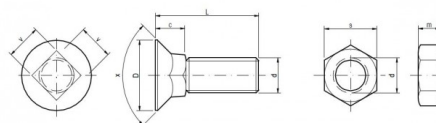

Specifikace

d	c	D	x	v	s	m
M 12	12,00	24,00	90° + 5°	12,00	19,00	10,00
M 14	14,00	28,00	90° + 5°	14,00	22,00	11,00

Balení

Balení v krabicích / ks		Balení bez matic	Balení s maticemi
12 x 30	UNI 6104 (12.9)	100	50/50
12 x 40	UNI 6104 (12.9)	150	100/100
12 x 50	UNI 6104 (12.9)	100	100/100
12 x 60	UNI 6104 (12.9)	90	50/50
12 x 70	UNI 6104 (12.9)	80	50/50
12 x 80	UNI 6104 (12.9)	60	50/50
14 x 35	UNI 6104 (12.9)	50	50/50
14 x 40	UNI 6104 (12.9)	50	50/50
14 x 45	UNI 6104 (12.9)	50	50/50
14 x 50	UNI 6104 (12.9)	50	50/50
14 x 60	UNI 6104 (12.9)	50	50/50
14 x 70	UNI 6104 (12.9)	50	50/50
14 x 80	UNI 6104 (12.9)	50	50/50

DIN 603 (8.8, 10.9)

Šrouby s velkou půlkulovou hlavou a čtyřhranem na pluky a kombajny s maticemi DIN 934 (8.8)

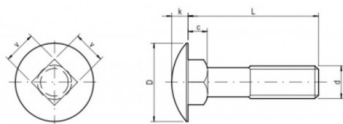

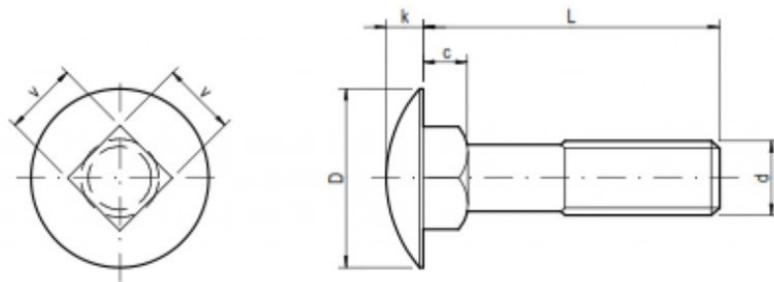

Specifikace

d	c	k	D	v	s
M 10	6,00	5,00	24,00	10,00	17,00
M 12	8,00	6,80	30,00	12,00	19,00

Balení

Balení v krabici / ks		balení bez matic	balení s maticemi
10 x 16	DIN 603 (8.8, 10.9)	200	150/150
10 x 20	DIN 603 (8.8, 10.9)	150	100/100
10 x 25	DIN 603 (8.8, 10.9)	150	100/100
10 x 30	DIN 603 (8.8, 10.9)	100	100/100
10 x 35	DIN 603 (8.8, 10.9)	200	150/150
10 x 40	DIN 603 (8.8, 10.9)	200	150/150
10 x 45	DIN 603 (8.8, 10.9)	150	150/150
10 x 50	DIN 603 (8.8, 10.9)	150	100/100
10 x 55	DIN 603 (8.8, 10.9)	150	100/100
10 x 60	DIN 603 (8.8, 10.9)	100	100/100
10 x 65	DIN 603 (8.8, 10.9)	100	100/100
10 x 70	DIN 603 (8.8, 10.9)	100	100/100
10 x 75	DIN 603 (8.8, 10.9)	100	100/100
10 x 80	DIN 603 (8.8, 10.9)	100	50/50
10 x 85	DIN 603 (8.8, 10.9)	80	50/50
10 x 90	DIN 603 (8.8, 10.9)	80	50/50
10 x 95	DIN 603 (8.8, 10.9)	60	50/50
10 x 100	DIN 603 (8.8, 10.9)	60	50/50
12 x 25	DIN 603 (8.8, 10.9)	150	100/100
12 x 30	DIN 603 (8.8, 10.9)	150	100/100
12 x 35	DIN 603 (8.8, 10.9)	100	100/100
12 x 40	DIN 603 (8.8, 10.9)	100	100/100
12 x 45	DIN 603 (8.8, 10.9)	100	100/100
12 x 50	DIN 603 (8.8, 10.9)	80	50/50
12 x 55	DIN 603 (8.8, 10.9)	80	50/50
12 x 60	DIN 603 (8.8, 10.9)	80	50/50
12 x 65	DIN 603 (8.8, 10.9)	80	50/50
12 x 70	DIN 603 (8.8, 10.9)	60	50/50
12 x 75	DIN 603 (8.8, 10.9)	60	50/50
12 x 80	DIN 603 (8.8, 10.9)	60	50/50
12 x 85	DIN 603 (8.8, 10.9)	50	50/50
12 x 90	DIN 603 (8.8, 10.9)	50	50/50
12 x 95	DIN 603 (8.8, 10.9)	50	50/50
12 x 100	DIN 603 (8.8, 10.9)	50	50/50

DIN 603 (12.9)

šrouby s velkou půlkulovou hlavou a čtyřhranem na pluky a kombajny s maticemi DIN 934 (10.9)

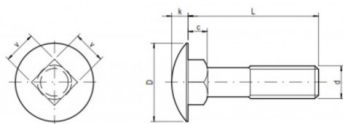

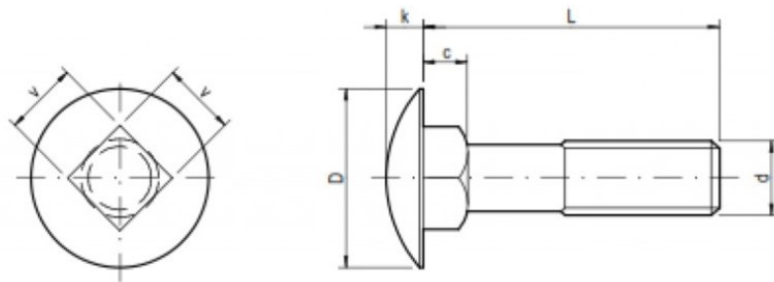

Specifikace

d	c	k	D	v	s
M 10	6,00	5,00	24,00	10,00	17,00
M 12	8,00	6,80	30,00	12,00	19,00

Balení

Balení v krabici / ks		balení bez matic	balení s maticemi
10 x 16	DIN 603 (12.9)	200	150/150
10 x 20	DIN 603 (12.9)	150	100/100
10 x 25	DIN 603 (12.9)	150	100/100
10 x 30	DIN 603 (12.9)	100	100/100
10 x 35	DIN 603 (12.9)	200	150/150
10 x 40	DIN 603 (12.9)	200	150/150
10 x 45	DIN 603 (12.9)	150	150/150
10 x 50	DIN 603 (12.9)	150	100/100
10 x 55	DIN 603 (12.9)	150	100/100
10 x 60	DIN 603 (12.9)	100	100/100
10 x 65	DIN 603 (12.9)	100	100/100
10 x 70	DIN 603 (12.9)	100	100/100
10 x 75	DIN 603 (12.9)	100	100/100
10 x 80	DIN 603 (12.9)	100	50/50
10 x 85	DIN 603 (12.9)	80	50/50
10 x 90	DIN 603 (12.9)	80	50/50
10 x 95	DIN 603 (12.9)	60	50/50
10 x 100	DIN 603 (12.9)	60	50/50
12 x 25	DIN 603 (12.9)	150	100/100
12 x 30	DIN 603 (12.9)	150	100/100
12 x 35	DIN 603 (12.9)	100	100/100
12 x 40	DIN 603 (12.9)	100	100/100
12 x 45	DIN 603 (12.9)	100	100/100
12 x 50	DIN 603 (12.9)	80	50/50
12 x 55	DIN 603 (12.9)	80	50/50
12 x 60	DIN 603 (12.9)	80	50/50
12 x 65	DIN 603 (12.9)	80	50/50
12 x 70	DIN 603 (12.9)	60	50/50
12 x 75	DIN 603 (12.9)	60	50/50
12 x 80	DIN 603 (12.9)	60	50/50
12 x 85	DIN 603 (12.9)	50	50/50
12 x 90	DIN 603 (12.9)	50	50/50
12 x 95	DIN 603 (12.9)	50	50/50
12 x 100	DIN 603 (12.9)	50	50/50

DIN 603 (4.8)

ČSN ISO 8677 (4.8) vratové šrouby se čtyřhranem

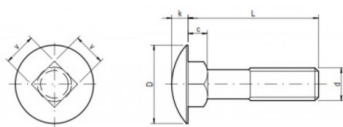

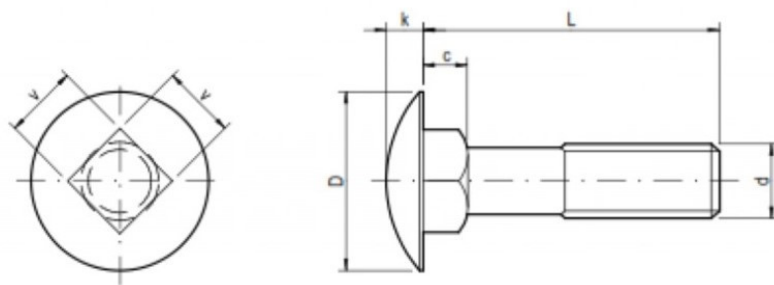

Specifikace

d	c	k	D	v
M 5	3,50	3,00	13,00	5,00
M 6	4,00	3,50	16,00	6,00
M 8	5,00	4,50	20,00	8,00
M 10	6,00	5,00	24,00	10,00
M 12	8,00	6,50	30,00	12,00

Balení

Balení v krabici / ks		krabice/ks
5 x 12	DIN 603 (4.8)	900
5 x 16	DIN 603 (4.8)	900
5 x 20	DIN 603 (4.8)	800
5 x 25	DIN 603 (4.8)	600
5 x 30	DIN 603 (4.8)	500
5 x 35	DIN 603 (4.8)	400
5 x 40	DIN 603 (4.8)	400
5 x 45	DIN 603 (4.8)	300
5 x 50	DIN 603 (4.8)	300
5 x 55	DIN 603 (4.8)	250
5 x 60	DIN 603 (4.8)	200
6 x 12	DIN 603 (4.8)	600
6 x 16	DIN 603 (4.8)	600
6 x 20	DIN 603 (4.8)	500
6 x 25	DIN 603 (4.8)	400
6 x 30	DIN 603 (4.8)	300
6 x 35	DIN 603 (4.8)	300
6 x 40	DIN 603 (4.8)	250
6 x 45	DIN 603 (4.8)	200
6 x 50	DIN 603 (4.8)	200
6 x 55	DIN 603 (4.8)	300
6 x 60	DIN 603 (4.8)	300
6 x 65	DIN 603 (4.8)	300
6 x 70	DIN 603 (4.8)	250
6 x 75	DIN 603 (4.8)	200
6 x 80	DIN 603 (4.8)	200
6 x 85	DIN 603 (4.8)	150
8 x 15	DIN 603 (4.8)	300
8 x 16	DIN 603 (4.8)	300

8 x 20	DIN 603 (4.8)	250
8 x 25	DIN 603 (4.8)	250
8 x 30	DIN 603 (4.8)	200
8 x 35	DIN 603 (4.8)	150
8 x 40	DIN 603 (4.8)	150
8 x 45	DIN 603 (4.8)	250
8 x 50	DIN 603 (4.8)	250
8 x 55	DIN 603 (4.8)	200
8 x 60	DIN 603 (4.8)	200
8 x 65	DIN 603 (4.8)	200
8 x 70	DIN 603 (4.8)	150
8 x 75	DIN 603 (4.8)	150
8 x 80	DIN 603 (4.8)	150
8 x 85	DIN 603 (4.8)	100
8 x 90	DIN 603 (4.8)	100
8 x 95	DIN 603 (4.8)	100
8 x 100	DIN 603 (4.8)	100
10 x 16	DIN 603 (4.8)	200
10 x 20	DIN 603 (4.8)	150
10 x 25	DIN 603 (4.8)	150
10 x 30	DIN 603 (4.8)	100
10 x 35	DIN 603 (4.8)	200
10 x 40	DIN 603 (4.8)	200
10 x 45	DIN 603 (4.8)	150
10 x 50	DIN 603 (4.8)	150
10 x 55	DIN 603 (4.8)	150
10 x 60	DIN 603 (4.8)	100
10 x 65	DIN 603 (4.8)	100
10 x 70	DIN 603 (4.8)	100
10 x 75	DIN 603 (4.8)	100
10 x 80	DIN 603 (4.8)	100
10 x 85	DIN 603 (4.8)	80
10 x 90	DIN 603 (4.8)	80
10 x 95	DIN 603 (4.8)	60
10 x 100	DIN 603 (4.8)	60
12 x 25	DIN 603 (4.8)	150
12 x 30	DIN 603 (4.8)	150
12 x 35	DIN 603 (4.8)	100
12 x 40	DIN 603 (4.8)	100
12 x 45	DIN 603 (4.8)	100
12 x 50	DIN 603 (4.8)	80
12 x 55	DIN 603 (4.8)	80
12 x 60	DIN 603 (4.8)	80
12 x 65	DIN 603 (4.8)	80
12 x 70	DIN 603 (4.8)	60
12 x 75	DIN 603 (4.8)	60
12 x 80	DIN 603 (4.8)	60
12 x 85	DIN 603 (4.8)	50
12 x 90	DIN 603 (4.8)	50
12 x 95	DIN 603 (4.8)	50
12 x 100	DIN 603 (4.8)	50

DIN 603 (8.8, 10.9)

ČSN ISO 8677 (8.8, 10.9) vratové šrouby se čtyřhranem

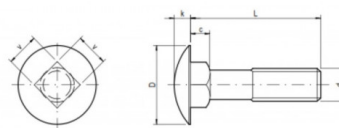

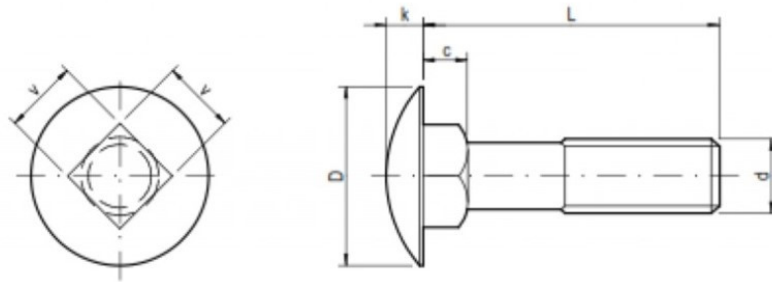

Specifikace

d	c	k	D	v
M 6	4,00	3,50	16,00	6,00
M 8	5,00	4,50	20,00	8,00
M 10	6,00	5,00	24,00	10,00
M 12	8,00	6,50	30,00	12,00

Balení

Balení v krabici / ks		krabice/ks
6 x 12	DIN 603 (8.8, 10.9)	600
6 x 16	DIN 603 (8.8, 10.9)	600
6 x 20	DIN 603 (8.8, 10.9)	500
6 x 25	DIN 603 (8.8, 10.9)	400
6 x 30	DIN 603 (8.8, 10.9)	300
6 x 35	DIN 603 (8.8, 10.9)	300
6 x 40	DIN 603 (8.8, 10.9)	250
6 x 45	DIN 603 (8.8, 10.9)	200
6 x 50	DIN 603 (8.8, 10.9)	200
6 x 55	DIN 603 (8.8, 10.9)	300
6 x 60	DIN 603 (8.8, 10.9)	300
6 x 65	DIN 603 (8.8, 10.9)	300
6 x 70	DIN 603 (8.8, 10.9)	250
6 x 75	DIN 603 (8.8, 10.9)	200
6 x 80	DIN 603 (8.8, 10.9)	200
6 x 85	DIN 603 (8.8, 10.9)	150
8 x 15	DIN 603 (8.8, 10.9)	300
8 x 16	DIN 603 (8.8, 10.9)	300
8 x 20	DIN 603 (8.8, 10.9)	250
8 x 25	DIN 603 (8.8, 10.9)	250
8 x 30	DIN 603 (8.8, 10.9)	200
8 x 35	DIN 603 (8.8, 10.9)	150
8 x 40	DIN 603 (8.8, 10.9)	150
8 x 45	DIN 603 (8.8, 10.9)	250
8 x 50	DIN 603 (8.8, 10.9)	250
8 x 55	DIN 603 (8.8, 10.9)	200
8 x 60	DIN 603 (8.8, 10.9)	200
8 x 65	DIN 603 (8.8, 10.9)	200
8 x 70	DIN 603 (8.8, 10.9)	150
8 x 75	DIN 603 (8.8, 10.9)	150
8 x 80	DIN 603 (8.8, 10.9)	150
8 x 85	DIN 603 (8.8, 10.9)	100

8 x 90	DIN 603 (8.8, 10.9)	100
8 x 95	DIN 603 (8.8, 10.9)	100
8 x 100	DIN 603 (8.8, 10.9)	100
10 x 16	DIN 603 (8.8, 10.9)	200
10 x 20	DIN 603 (8.8, 10.9)	150
10 x 25	DIN 603 (8.8, 10.9)	150
10 x 30	DIN 603 (8.8, 10.9)	100
10 x 35	DIN 603 (8.8, 10.9)	200
10 x 40	DIN 603 (8.8, 10.9)	200
10 x 45	DIN 603 (8.8, 10.9)	150
10 x 50	DIN 603 (8.8, 10.9)	150
10 x 55	DIN 603 (8.8, 10.9)	150
10 x 60	DIN 603 (8.8, 10.9)	100
10 x 65	DIN 603 (8.8, 10.9)	100
10 x 70	DIN 603 (8.8, 10.9)	100
10 x 75	DIN 603 (8.8, 10.9)	100
10 x 80	DIN 603 (8.8, 10.9)	100
10 x 85	DIN 603 (8.8, 10.9)	80
10 x 90	DIN 603 (8.8, 10.9)	80
10 x 95	DIN 603 (8.8, 10.9)	60
10 x 100	DIN 603 (8.8, 10.9)	60
12 x 25	DIN 603 (8.8, 10.9)	150
12 x 30	DIN 603 (8.8, 10.9)	150
12 x 35	DIN 603 (8.8, 10.9)	100
12 x 40	DIN 603 (8.8, 10.9)	100
12 x 45	DIN 603 (8.8, 10.9)	100
12 x 50	DIN 603 (8.8, 10.9)	80
12 x 55	DIN 603 (8.8, 10.9)	80
12 x 60	DIN 603 (8.8, 10.9)	80
12 x 65	DIN 603 (8.8, 10.9)	80
12 x 70	DIN 603 (8.8, 10.9)	60
12 x 75	DIN 603 (8.8, 10.9)	60
12 x 80	DIN 603 (8.8, 10.9)	60
12 x 85	DIN 603 (8.8, 10.9)	50
12 x 90	DIN 603 (8.8, 10.9)	50
12 x 95	DIN 603 (8.8, 10.9)	50
12 x 100	DIN 603 (8.8, 10.9)	50

DIN 603 (12.9)

ČSN ISO 8677 (12.9) vratové šrouby se čtyřhranem

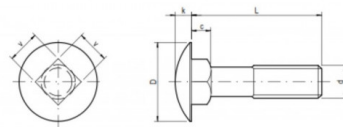

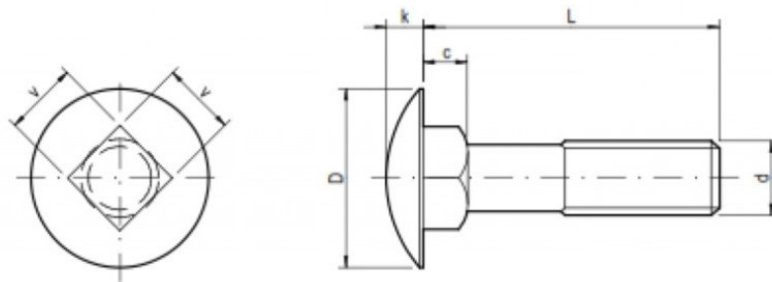

Specifikace

d	c	k	D	v
M 10	6,00	5,00	24,00	10,00
M 12	8,00	6,50	30,00	12,00

Balení

Balení v krabici / ks		krabice/ks
10 x 16	DIN 603 (12.9)	200
10 x 20	DIN 603 (12.9)	150
10 x 25	DIN 603 (12.9)	150
10 x 30	DIN 603 (12.9)	100
10 x 35	DIN 603 (12.9)	200
10 x 40	DIN 603 (12.9)	200
10 x 45	DIN 603 (12.9)	150
10 x 50	DIN 603 (12.9)	150
10 x 55	DIN 603 (12.9)	150
10 x 60	DIN 603 (12.9)	100
10 x 65	DIN 603 (12.9)	100
10 x 70	DIN 603 (12.9)	100
10 x 75	DIN 603 (12.9)	100
10 x 80	DIN 603 (12.9)	100
10 x 85	DIN 603 (12.9)	80
10 x 90	DIN 603 (12.9)	80
10 x 95	DIN 603 (12.9)	60
10 x 100	DIN 603 (12.9)	60
12 x 25	DIN 603 (12.9)	150
12 x 30	DIN 603 (12.9)	150
12 x 35	DIN 603 (12.9)	100
12 x 40	DIN 603 (12.9)	100
12 x 45	DIN 603 (12.9)	100
12 x 50	DIN 603 (12.9)	80
12 x 55	DIN 603 (12.9)	80
12 x 60	DIN 603 (12.9)	80
12 x 65	DIN 603 (12.9)	80
12 x 70	DIN 603 (12.9)	60
12 x 75	DIN 603 (12.9)	60
12 x 80	DIN 603 (12.9)	60
12 x 85	DIN 603 (12.9)	50
12 x 90	DIN 603 (12.9)	50
12 x 95	DIN 603 (12.9)	50
12 x 100	DIN 603 (12.9)	50

DIN 933 (5.8) **šestihranné šrouby - celozávit**

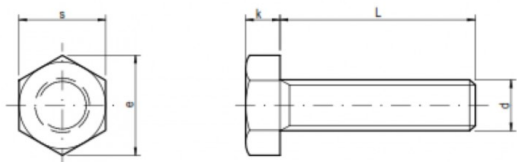

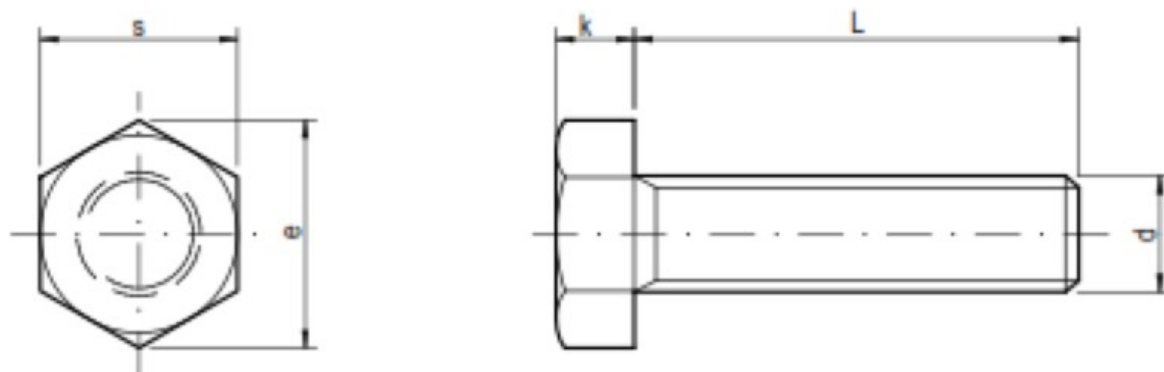

Specifikace

d	k	s	e
M 6	4,00	10,00	11,05
M 8	5,50	13,00	14,38
M 10	7,00	17,00	18,72
M 12	8,00	19,00	20,88

Balení

Balení v krabici / ks		krabice/ks
6 x 10	DIN 933 (5.8)	1000
6 x 12	DIN 933 (5.8)	1000
6 x 14	DIN 933 (5.8)	900
6 x 16	DIN 933 (5.8)	800
6 x 18	DIN 933 (5.8)	800
6 x 20	DIN 933 (5.8)	700
6 x 22	DIN 933 (5.8)	600
6 x 25	DIN 933 (5.8)	500
6 x 30	DIN 933 (5.8)	400
6 x 35	DIN 933 (5.8)	400

6 x 40	DIN 933 (5.8)	300
6 x 45	DIN 933 (5.8)	300
6 x 50	DIN 933 (5.8)	200
6 x 55	DIN 933 (5.8)	200
6 x 60	DIN 933 (5.8)	200
8 x 12	DIN 933 (5.8)	500
8 x 14	DIN 933 (5.8)	400
8 x 16	DIN 933 (5.8)	400
8 x 18	DIN 933 (5.8)	400
8 x 20	DIN 933 (5.8)	300
8 x 22	DIN 933 (5.8)	300
8 x 25	DIN 933 (5.8)	300
8 x 30	DIN 933 (5.8)	250
8 x 35	DIN 933 (5.8)	200
8 x 40	DIN 933 (5.8)	200
8 x 45	DIN 933 (5.8)	150
8 x 50	DIN 933 (5.8)	150
8 x 55	DIN 933 (5.8)	100
8 x 60	DIN 933 (5.8)	100
8 x 65	DIN 933 (5.8)	200
8 x 70	DIN 933 (5.8)	200
8 x 75	DIN 933 (5.8)	150
8 x 80	DIN 933 (5.8)	150
8 x 85	DIN 933 (5.8)	100
8 x 90	DIN 933 (5.8)	100
8 x 95	DIN 933 (5.8)	100
8 x 100	DIN 933 (5.8)	100
10 x 16	DIN 933 (5.8)	200
10 x 20	DIN 933 (5.8)	200
10 x 22	DIN 933 (5.8)	150
10 x 25	DIN 933 (5.8)	150
10 x 30	DIN 933 (5.8)	150
10 x 35	DIN 933 (5.8)	100
10 x 40	DIN 933 (5.8)	100
10 x 45	DIN 933 (5.8)	100
10 x 50	DIN 933 (5.8)	100
10 x 55	DIN 933 (5.8)	150
10 x 60	DIN 933 (5.8)	150
10 x 65	DIN 933 (5.8)	150
10 x 70	DIN 933 (5.8)	100
10 x 75	DIN 933 (5.8)	100
10 x 80	DIN 933 (5.8)	100
10 x 85	DIN 933 (5.8)	100
10 x 90	DIN 933 (5.8)	80
10 x 95	DIN 933 (5.8)	80
10 x 100	DIN 933 (5.8)	80
12 x 16	DIN 933 (5.8)	300
12 x 20	DIN 933 (5.8)	250
12 x 25	DIN 933 (5.8)	250
12 x 30	DIN 933 (5.8)	200

12 x 35	DIN 933 (5.8)	150
12 x 40	DIN 933 (5.8)	150
12 x 45	DIN 933 (5.8)	150
12 x 50	DIN 933 (5.8)	100
12 x 55	DIN 933 (5.8)	100
12 x 60	DIN 933 (5.8)	100
12 x 65	DIN 933 (5.8)	100
12 x 70	DIN 933 (5.8)	80
12 x 75	DIN 933 (5.8)	80
12 x 80	DIN 933 (5.8)	80
12 x 85	DIN 933 (5.8)	60
12 x 90	DIN 933 (5.8)	60
12 x 95	DIN 933 (5.8)	50
12 x 100	DIN 933 (5.8)	50

ISO 4017 (5.8)

šestihranné šrouby - celozávit

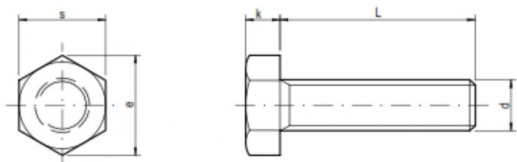

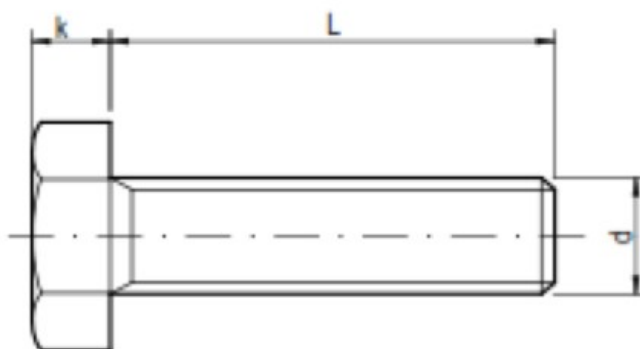
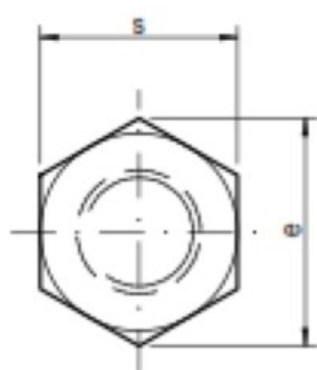

Specifikace

d	k	s	e
M 10	6,40	16,00	17,77
M 12	7,50	18,00	20,03

Balení

Balení v krabici / ks		krabice/ks
10 x 16	ISO 4017 (5.8)	200
10 x 22	ISO 4017 (5.8)	200
10 x 20	ISO 4017 (5.8)	200
10 x 25	ISO 4017 (5.8)	150
10 x 30	ISO 4017 (5.8)	150
10 x 35	ISO 4017 (5.8)	100
10 x 40	ISO 4017 (5.8)	100
10 x 45	ISO 4017 (5.8)	100
10 x 50	ISO 4017 (5.8)	100
10 x 55	ISO 4017 (5.8)	150
10 x 60	ISO 4017 (5.8)	150
10 x 65	ISO 4017 (5.8)	150

10 x 70	ISO 4017 (5.8)	100
10 x 75	ISO 4017 (5.8)	100
10 x 80	ISO 4017 (5.8)	100
10 x 90	ISO 4017 (5.8)	80
10 x 100	ISO 4017 (5.8)	80
12 x 16	ISO 4017 (5.8)	300
12 x 18	ISO 4017 (5.8)	250
12 x 20	ISO 4017 (5.8)	250
12 x 22	ISO 4017 (5.8)	250
12 x 25	ISO 4017 (5.8)	250
12 x 30	ISO 4017 (5.8)	200
12 x 35	ISO 4017 (5.8)	150
12 x 40	ISO 4017 (5.8)	150
12 x 45	ISO 4017 (5.8)	150
12 x 50	ISO 4017 (5.8)	100
12 x 55	ISO 4017 (5.8)	100
12 x 60	ISO 4017 (5.8)	100
12 x 65	ISO 4017 (5.8)	100
12 x 70	ISO 4017 (5.8)	80
12 x 75	ISO 4017 (5.8)	80
12 x 80	ISO 4017 (5.8)	80
12 x 90	ISO 4017 (5.8)	60
12 x 100	ISO 4017 (5.8)	50

DIN 604 (4.8, 8.8)

ČSN 02 1324 (4.8, 8.8) šrouby zápusťné s nosem

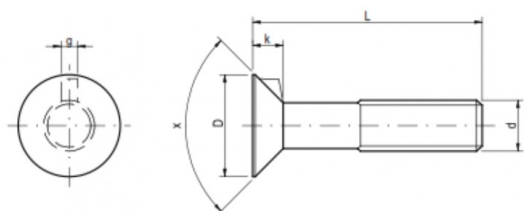

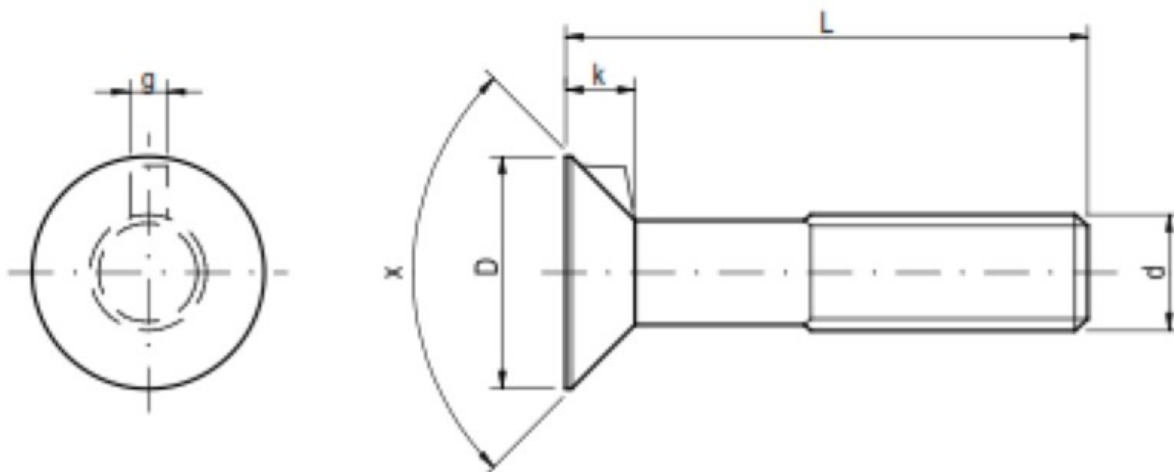

Specifikace

d	k	D	x	g
M 6	4,00	12,00	90°	2,50
M 8	5,00	16,00	90°	3,00
M 10	6,00	19,00	90°	3,20
M 12	7,00	24,00	90°	3,60

Balení

Balení v krabici / ks		krabice/ks
6 x 20	DIN 604 (4.8, 8.8)	500
6 x 25	DIN 604 (4.8, 8.8)	400
6 x 30	DIN 604 (4.8, 8.8)	300
6 x 35	DIN 604 (4.8, 8.8)	300
6 x 40	DIN 604 (4.8, 8.8)	250
6 x 45	DIN 604 (4.8, 8.8)	200
6 x 50	DIN 604 (4.8, 8.8)	200
6 x 55	DIN 604 (4.8, 8.8)	300
6 x 60	DIN 604 (4.8, 8.8)	300
6 x 65	DIN 604 (4.8, 8.8)	300

6 x 70	DIN 604 (4.8, 8.8)	250
6 x 75	DIN 604 (4.8, 8.8)	200
6 x 80	DIN 604 (4.8, 8.8)	200
8 x 20	DIN 604 (4.8, 8.8)	250
8 x 25	DIN 604 (4.8, 8.8)	250
8 x 30	DIN 604 (4.8, 8.8)	200
8 x 35	DIN 604 (4.8, 8.8)	150
8 x 40	DIN 604 (4.8, 8.8)	150
8 x 45	DIN 604 (4.8, 8.8)	250
8 x 50	DIN 604 (4.8, 8.8)	250
8 x 55	DIN 604 (4.8, 8.8)	200
8 x 60	DIN 604 (4.8, 8.8)	200
8 x 65	DIN 604 (4.8, 8.8)	200
8 x 70	DIN 604 (4.8, 8.8)	150
8 x 75	DIN 604 (4.8, 8.8)	150
8 x 80	DIN 604 (4.8, 8.8)	150
8 x 90	DIN 604 (4.8, 8.8)	100
8 x 100	DIN 604 (4.8, 8.8)	100
10 x 20	DIN 604 (4.8, 8.8)	150
10 x 25	DIN 604 (4.8, 8.8)	150
10 x 30	DIN 604 (4.8, 8.8)	100
10 x 35	DIN 604 (4.8, 8.8)	200
10 x 40	DIN 604 (4.8, 8.8)	200
10 x 45	DIN 604 (4.8, 8.8)	150
10 x 50	DIN 604 (4.8, 8.8)	150
10 x 55	DIN 604 (4.8, 8.8)	150
10 x 60	DIN 604 (4.8, 8.8)	100
10 x 65	DIN 604 (4.8, 8.8)	100
10 x 70	DIN 604 (4.8, 8.8)	100
10 x 75	DIN 604 (4.8, 8.8)	100
10 x 80	DIN 604 (4.8, 8.8)	100
10 x 90	DIN 604 (4.8, 8.8)	80
10 x 100	DIN 604 (4.8, 8.8)	60
12 x 20	DIN 604 (4.8, 8.8)	150
12 x 25	DIN 604 (4.8, 8.8)	150
12 x 30	DIN 604 (4.8, 8.8)	100
12 x 35	DIN 604 (4.8, 8.8)	100
12 x 40	DIN 604 (4.8, 8.8)	150
12 x 45	DIN 604 (4.8, 8.8)	150
12 x 50	DIN 604 (4.8, 8.8)	100
12 x 55	DIN 604 (4.8, 8.8)	100
12 x 60	DIN 604 (4.8, 8.8)	100
12 x 65	DIN 604 (4.8, 8.8)	90
12 x 70	DIN 604 (4.8, 8.8)	80
12 x 75	DIN 604 (4.8, 8.8)	80
12 x 80	DIN 604 (4.8, 8.8)	60
12 x 90	DIN 604 (4.8, 8.8)	50
12 x 100	DIN 604 (4.8, 8.8)	50

DIN 605 (4.8, 8.8, 10.9)

ČSN 02 1327 (4.8, 8.8, 10.9) zápustné šrouby se čtyřhranem do dřeva

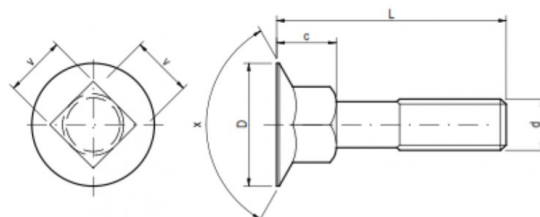

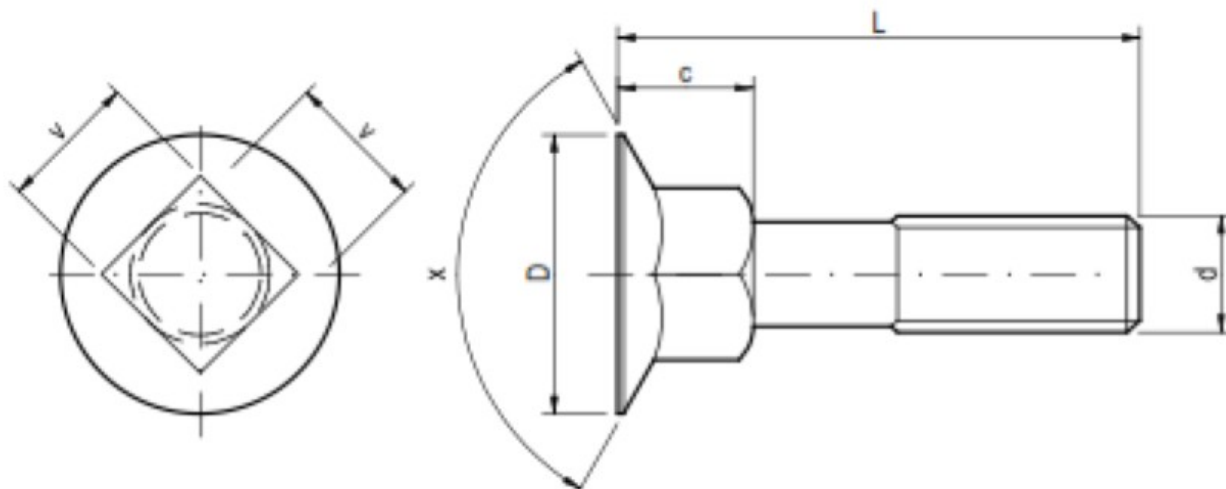

Specifikace

d	c	D	x	v
M 6	7,00	16,00	120°	6,00
M 8	9,00	20,00	120°	8,00
M 10	11,00	24,00	120°	10,00
M 12	14,00	28,00	120°	12,00

Balení

Balení v krabici / ks		krabice/ks
6 x 30	DIN 605 (4.8, 8.8, 10.9)	300
6 x 35	DIN 605 (4.8, 8.8, 10.9)	300
6 x 40	DIN 605 (4.8, 8.8, 10.9)	250
6 x 45	DIN 605 (4.8, 8.8, 10.9)	200
6 x 50	DIN 605 (4.8, 8.8, 10.9)	200
6 x 55	DIN 605 (4.8, 8.8, 10.9)	300
6 x 60	DIN 605 (4.8, 8.8, 10.9)	300
8 x 30	DIN 605 (4.8, 8.8, 10.9)	200
8 x 35	DIN 605 (4.8, 8.8, 10.9)	150
8 x 40	DIN 605 (4.8, 8.8, 10.9)	150
8 x 45	DIN 605 (4.8, 8.8, 10.9)	250
8 x 50	DIN 605 (4.8, 8.8, 10.9)	250
8 x 55	DIN 605 (4.8, 8.8, 10.9)	200
8 x 60	DIN 605 (4.8, 8.8, 10.9)	200
8 x 65	DIN 605 (4.8, 8.8, 10.9)	200
8 x 70	DIN 605 (4.8, 8.8, 10.9)	150
8 x 75	DIN 605 (4.8, 8.8, 10.9)	150
8 x 80	DIN 605 (4.8, 8.8, 10.9)	150
10 x 40	DIN 605 (4.8, 8.8, 10.9)	200
10 x 45	DIN 605 (4.8, 8.8, 10.9)	150
10 x 50	DIN 605 (4.8, 8.8, 10.9)	150
10 x 55	DIN 605 (4.8, 8.8, 10.9)	150
10 x 60	DIN 605 (4.8, 8.8, 10.9)	100
10 x 65	DIN 605 (4.8, 8.8, 10.9)	100
10 x 70	DIN 605 (4.8, 8.8, 10.9)	100
10 x 75	DIN 605 (4.8, 8.8, 10.9)	100
10 x 80	DIN 605 (4.8, 8.8, 10.9)	100

10 x 90	DIN 605 (4.8, 8.8, 10.9)	80
10 x 100	DIN 605 (4.8, 8.8, 10.9)	60
12 x 50	DIN 605 (4.8, 8.8, 10.9)	100
12 x 55	DIN 605 (4.8, 8.8, 10.9)	80
12 x 60	DIN 605 (4.8, 8.8, 10.9)	80
12 x 65	DIN 605 (4.8, 8.8, 10.9)	80
12 x 70	DIN 605 (4.8, 8.8, 10.9)	60
12 x 75	DIN 605 (4.8, 8.8, 10.9)	60
12 x 80	DIN 605 (4.8, 8.8, 10.9)	60
12 x 90	DIN 605 (4.8, 8.8, 10.9)	50
12 x 100	DIN 605 (4.8, 8.8, 10.9)	50

DIN 607 (4.8)

ČSN 02 1315 (4.8) šrouby s půlkulatou hlavou a s nosem

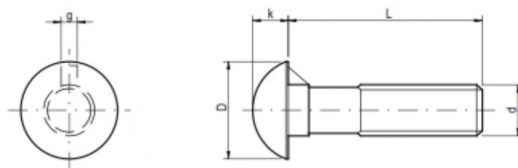

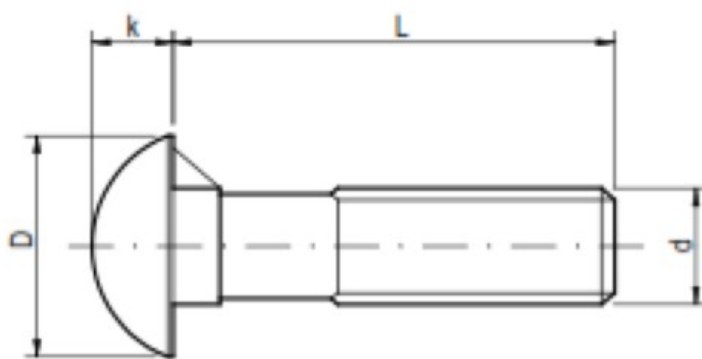
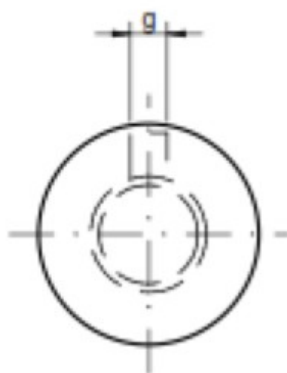

Specifikace

d	k	D	g
M 6	4,50	12,00	2,50
M 8	6,00	16,00	3,00
M 10	7,00	19,00	3,20
M 12	9,00	24,00	3,80

Balení

Balení v krabici / ks		krabice/ks
6 x 16	DIN 607 (4.8)	500
6 x 20	DIN 607 (4.8)	500
6 x 25	DIN 607 (4.8)	400
6 x 30	DIN 607 (4.8)	300
6 x 35	DIN 607 (4.8)	300
6 x 40	DIN 607 (4.8)	250
6 x 45	DIN 607 (4.8)	250
6 x 50	DIN 607 (4.8)	200
6 x 55	DIN 607 (4.8)	300
6 x 60	DIN 607 (4.8)	300
6 x 65	DIN 607 (4.8)	300
6 x 70	DIN 607 (4.8)	250
6 x 75	DIN 607 (4.8)	200
6 x 80	DIN 607 (4.8)	200
8 x 16	DIN 607 (4.8)	250
8 x 20	DIN 607 (4.8)	250
8 x 25	DIN 607 (4.8)	250
8 x 30	DIN 607 (4.8)	200
8 x 35	DIN 607 (4.8)	150
8 x 40	DIN 607 (4.8)	150
8 x 45	DIN 607 (4.8)	250
8 x 50	DIN 607 (4.8)	250
8 x 55	DIN 607 (4.8)	200
8 x 60	DIN 607 (4.8)	200
8 x 65	DIN 607 (4.8)	200
8 x 70	DIN 607 (4.8)	150
8 x 75	DIN 607 (4.8)	150
8 x 80	DIN 607 (4.8)	150

8 x 90	DIN 607 (4.8)	100
8 x 100	DIN 607 (4.8)	100
10 x 25	DIN 607 (4.8)	150
10 x 30	DIN 607 (4.8)	100
10 x 35	DIN 607 (4.8)	200
10 x 40	DIN 607 (4.8)	200
10 x 45	DIN 607 (4.8)	150
10 x 50	DIN 607 (4.8)	150
10 x 55	DIN 607 (4.8)	150
10 x 60	DIN 607 (4.8)	100
10 x 65	DIN 607 (4.8)	100
10 x 70	DIN 607 (4.8)	100
10 x 75	DIN 607 (4.8)	100
10 x 80	DIN 607 (4.8)	100
10 x 90	DIN 607 (4.8)	80
10 x 100	DIN 607 (4.8)	60
12 x 30	DIN 607 (4.8)	150
12 x 35	DIN 607 (4.8)	100
12 x 40	DIN 607 (4.8)	100
12 x 45	DIN 607 (4.8)	100
12 x 50	DIN 607 (4.8)	100
12 x 55	DIN 607 (4.8)	80
12 x 60	DIN 607 (4.8)	80
12 x 65	DIN 607 (4.8)	80
12 x 70	DIN 607 (4.8)	60
12 x 75	DIN 607 (4.8)	60
12 x 80	DIN 607 (4.8)	60
12 x 90	DIN 607 (4.8)	50
12 x 100	DIN 607 (4.8)	50

ČSN 02 1329 (4.8)

ČSN 02 1329 (4.8) korečkové šrouby zápustné

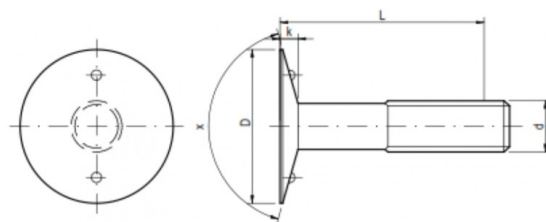

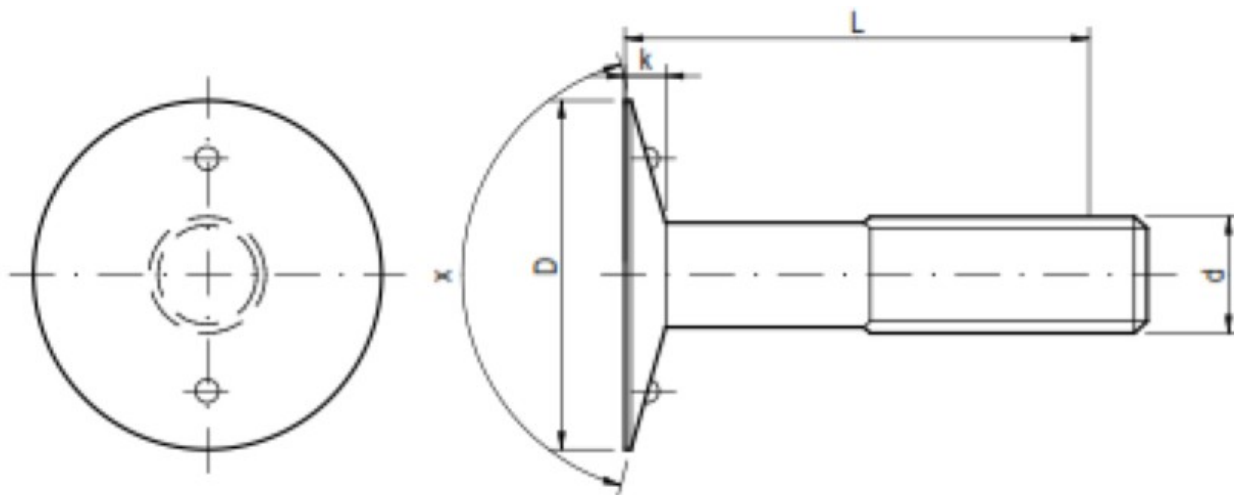

Specifikace

d	k	D	x
M 6	2,00	17,00	140°
M 8	2,80	23,00	140°
M 10	3,50	29,00	140°

Balení

Balení v krabici / ks		krabice/ks
6 x 16	ČSN 02 1329 (4.8)	500
6 x 20	ČSN 02 1329 (4.8)	400
6 x 25	ČSN 02 1329 (4.8)	300
6 x 30	ČSN 02 1329 (4.8)	250
6 x 35	ČSN 02 1329 (4.8)	250
6 x 40	ČSN 02 1329 (4.8)	200
8 x 20	ČSN 02 1329 (4.8)	200
8 x 25	ČSN 02 1329 (4.8)	200
8 x 30	ČSN 02 1329 (4.8)	150
8 x 35	ČSN 02 1329 (4.8)	100
8 x 40	ČSN 02 1329 (4.8)	100
8 x 55	ČSN 02 1329 (4.8)	200
10 x 25	ČSN 02 1329 (4.8)	100
10 x 30	ČSN 02 1329 (4.8)	100
10 x 35	ČSN 02 1329 (4.8)	150
10 x 40	ČSN 02 1329 (4.8)	150
10 x 45	ČSN 02 1329 (4.8)	150

ČSN 02 1318 (4.8)

ČSN 02 1318 (4.8) korečkové šrouby s plochou kulovou hlavou

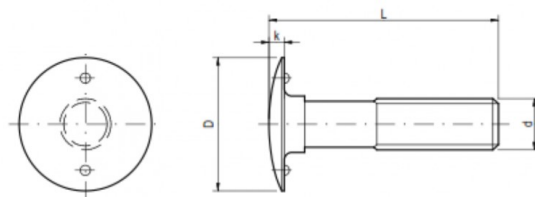

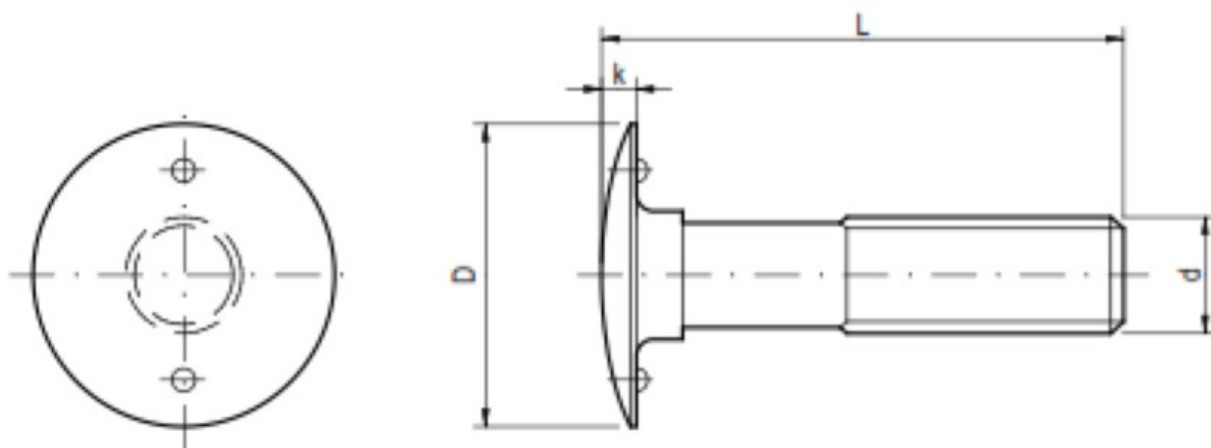

Specifikace

d	k	D
M 6	1,60	16,00
M 8	2,40	21,00
M 10	3,00	26,00

Balení

Balení v krabici / ks		krabice/ks
6 x 16	ČSN 02 1318 (4.8)	500
6 x 20	ČSN 02 1318 (4.8)	400
6 x 25	ČSN 02 1318 (4.8)	300
6 x 30	ČSN 02 1318 (4.8)	250
6 x 35	ČSN 02 1318 (4.8)	250
8 x 20	ČSN 02 1318 (4.8)	200
8 x 25	ČSN 02 1318 (4.8)	200
8 x 30	ČSN 02 1318 (4.8)	150
8 x 35	ČSN 02 1318 (4.8)	100
8 x 40	ČSN 02 1318 (4.8)	100
8 x 55	ČSN 02 1318 (4.8)	200
10 x 25	ČSN 02 1318 (4.8)	100
10 x 30	ČSN 02 1318 (4.8)	100
10 x 35	ČSN 02 1318 (4.8)	150
10 x 40	ČSN 02 1318 (4.8)	150
10 x 45	ČSN 02 1318 (4.8)	150

DIN 960 (5.8, 8.8, 10.9, 12.9)

Šestihranné šrouby s částečným jemným závitem

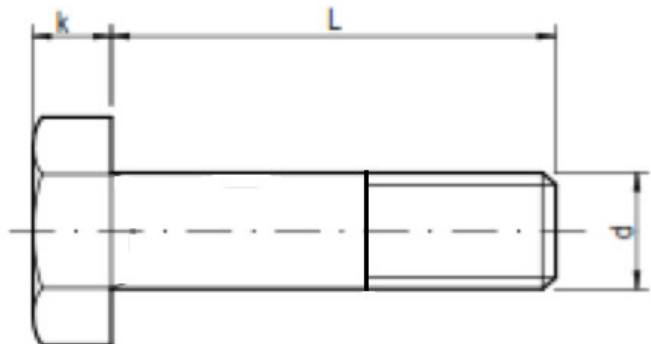
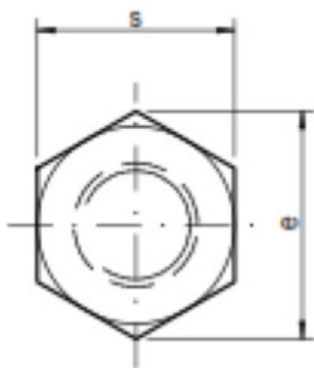
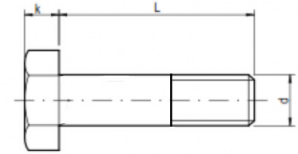
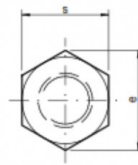

Specifikace

d	k	s	e
M 8	5,30	13,00	14,38
M 10	6,40	17,00	18,9
M 12	7,50	19,00	21,1
M 14	8,80	22,00	24,49
M16	10,00	24,00	26,75
M 18	11,50	27,00	30,14
M 20	12,50	30,00	33,53

Balení

Rozměr	Norma	krabice/ks	minimální objednáací množství/ks
8 x 1 x 25	DIN 960 5.8, 8.8, 10.9, 12.9	300	6 000
8 x 1 x 28	DIN 960 5.8, 8.8, 10.9, 12.9	250	6 000
8 x 1 x 30	DIN 960 5.8, 8.8, 10.9, 12.9	250	6 000
8 x 1 x 35	DIN 960 5.8, 8.8, 10.9, 12.9	200	6 000
8 x 1 x 40	DIN 960 5.8, 8.8, 10.9, 12.9	200	6 000
8 x 1 x 45	DIN 960 5.8, 8.8, 10.9, 12.9	150	6 000
8 x 1 x 50	DIN 960 5.8, 8.8, 10.9, 12.9	150	6 000
8 x 1 x 55	DIN 960 5.8, 8.8, 10.9, 12.9	100	6 000
8 x 1 x 60	DIN 960 5.8, 8.8, 10.9, 12.9	100	6 000
8 x 1 x 65	DIN 960 5.8, 8.8, 10.9, 12.9	200	6 000
8 x 1 x 70	DIN 960 5.8, 8.8, 10.9, 12.9	200	6 000
8 x 1 x 75	DIN 960 5.8, 8.8, 10.9, 12.9	150	6 000
8 x 1 x 80	DIN 960 5.8, 8.8, 10.9, 12.9	150	6 000
8 x 1 x 85	DIN 960 5.8, 8.8, 10.9, 12.9	100	6 000
8 x 1 x 90	DIN 960 5.8, 8.8, 10.9, 12.9	100	6 000
8 x 1 x 95	DIN 960 5.8, 8.8, 10.9, 12.9	100	6 000
10 x 1 x 30	DIN 960 5.8, 8.8, 10.9, 12.9	150	5 000
10 x 1 x 35	DIN 960 5.8, 8.8, 10.9, 12.9	100	5 000
10 x 1 x 40	DIN 960 5.8, 8.8, 10.9, 12.9	100	5 000
10 x 1 x 45	DIN 960 5.8, 8.8, 10.9, 12.9	100	5 000
10 x 1 x 50	DIN 960 5.8, 8.8, 10.9, 12.9	100	5 000
10 x 1 x 55	DIN 960 5.8, 8.8, 10.9, 12.9	150	5 000
10 x 1 x 60	DIN 960 5.8, 8.8, 10.9, 12.9	150	5 000
10 x 1 x 65	DIN 960 5.8, 8.8, 10.9, 12.9	150	5 000
10 x 1 x 70	DIN 960 5.8, 8.8, 10.9, 12.9	100	5 000
10 x 1 x 75	DIN 960 5.8, 8.8, 10.9, 12.9	100	5 000
10 x 1 x 80	DIN 960 5.8, 8.8, 10.9, 12.9	100	5 000
10 x 1 x 85	DIN 960 5.8, 8.8, 10.9, 12.9	100	5 000
10 x 1 x 90	DIN 960 5.8, 8.8, 10.9, 12.9	80	5 000
10 x 1 x 95	DIN 960 5.8, 8.8, 10.9, 12.9	80	5 000
10 x 1 x 100	DIN 960 5.8, 8.8, 10.9, 12.9	80	5 000
10 x 1 x 105	DIN 960 5.8, 8.8, 10.9, 12.9	50	5 000
10 x 1 x 110	DIN 960 5.8, 8.8, 10.9, 12.9	50	5 000
10 x 1 x 115	DIN 960 5.8, 8.8, 10.9, 12.9	50	5 000
10 x 1 x 120	DIN 960 5.8, 8.8, 10.9, 12.9	50	5 000
10 x 1,25 x 30	DIN 960 5.8, 8.8, 10.9, 12.9	150	5 000

10 x 1,25 x 35	DIN 960 5.8, 8.8, 10.9, 12.9	100	5 000
10 x 1,25 x 40	DIN 960 5.8, 8.8, 10.9, 12.9	100	5 000
10 x 1,25 x 45	DIN 960 5.8, 8.8, 10.9, 12.9	100	5 000
10 x 1,25 x 50	DIN 960 5.8, 8.8, 10.9, 12.9	100	5 000
10 x 1,25 x 55	DIN 960 5.8, 8.8, 10.9, 12.9	150	5 000
10 x 1,25 x 60	DIN 960 5.8, 8.8, 10.9, 12.9	150	5 000
10 x 1,25 x 65	DIN 960 5.8, 8.8, 10.9, 12.9	150	5 000
10 x 1,25 x 70	DIN 960 5.8, 8.8, 10.9, 12.9	100	5 000
10 x 1,25 x 75	DIN 960 5.8, 8.8, 10.9, 12.9	100	5 000
10 x 1,25 x 80	DIN 960 5.8, 8.8, 10.9, 12.9	100	5 000
10 x 1,25 x 85	DIN 960 5.8, 8.8, 10.9, 12.9	100	5 000
10 x 1,25 x 90	DIN 960 5.8, 8.8, 10.9, 12.9	80	5 000
10 x 1,25 x 95	DIN 960 5.8, 8.8, 10.9, 12.9	80	5 000
10 x 1,25 x 100	DIN 960 5.8, 8.8, 10.9, 12.9	80	5 000
10 x 1,25 x 105	DIN 960 5.8, 8.8, 10.9, 12.9	50	5 000
10 x 1,25 x 110	DIN 960 5.8, 8.8, 10.9, 12.9	50	5 000
10 x 1,25 x 115	DIN 960 5.8, 8.8, 10.9, 12.9	50	5 000
10 x 1,25 x 120	DIN 960 5.8, 8.8, 10.9, 12.9	50	5 000
12 x 1,25 x 30	DIN 960 5.8, 8.8, 10.9, 12.9	200	3 000
12 x 1,25 x 35	DIN 960 5.8, 8.8, 10.9, 12.9	150	3 000
12 x 1,25 x 40	DIN 960 5.8, 8.8, 10.9, 12.9	150	3 000
12 x 1,25 x 45	DIN 960 5.8, 8.8, 10.9, 12.9	150	3 000
12 x 1,25 x 50	DIN 960 5.8, 8.8, 10.9, 12.9	100	3 000
12 x 1,25 x 55	DIN 960 5.8, 8.8, 10.9, 12.9	100	3 000
12 x 1,25 x 60	DIN 960 5.8, 8.8, 10.9, 12.9	100	3 000
12 x 1,25 x 65	DIN 960 5.8, 8.8, 10.9, 12.9	100	3 000
12 x 1,25 x 70	DIN 960 5.8, 8.8, 10.9, 12.9	80	3 000
12 x 1,25 x 75	DIN 960 5.8, 8.8, 10.9, 12.9	80	3 000
12 x 1,25 x 80	DIN 960 5.8, 8.8, 10.9, 12.9	80	3 000
12 x 1,25 x 85	DIN 960 5.8, 8.8, 10.9, 12.9	60	3 000
12 x 1,25 x 90	DIN 960 5.8, 8.8, 10.9, 12.9	60	3 000
12 x 1,25 x 95	DIN 960 5.8, 8.8, 10.9, 12.9	50	3 000
12 x 1,25 x 100	DIN 960 5.8, 8.8, 10.9, 12.9	50	3 000
12 x 1,25 x 105	DIN 960 5.8, 8.8, 10.9, 12.9	50	3 000
12 x 1,25 x 110	DIN 960 5.8, 8.8, 10.9, 12.9	50	3 000
12 x 1,25 x 115	DIN 960 5.8, 8.8, 10.9, 12.9	25	3 000
12 x 1,25 x 120	DIN 960 5.8, 8.8, 10.9, 12.9	25	3 000
12 x 1,5 x 30	DIN 960 5.8, 8.8, 10.9, 12.9	200	3 000
12 x 1,5 x 35	DIN 960 5.8, 8.8, 10.9, 12.9	150	3 000
12 x 1,5 x 40	DIN 960 5.8, 8.8, 10.9, 12.9	150	3 000
12 x 1,5 x 45	DIN 960 5.8, 8.8, 10.9, 12.9	150	3 000
12 x 1,5 x 50	DIN 960 5.8, 8.8, 10.9, 12.9	100	3 000
12 x 1,5 x 55	DIN 960 5.8, 8.8, 10.9, 12.9	100	3 000
12 x 1,5 x 60	DIN 960 5.8, 8.8, 10.9, 12.9	100	3 000
12 x 1,5 x 65	DIN 960 5.8, 8.8, 10.9, 12.9	100	3 000
12 x 1,5 x 70	DIN 960 5.8, 8.8, 10.9, 12.9	80	3 000
12 x 1,5 x 75	DIN 960 5.8, 8.8, 10.9, 12.9	80	3 000
12 x 1,5 x 80	DIN 960 5.8, 8.8, 10.9, 12.9	80	3 000
12 x 1,5 x 85	DIN 960 5.8, 8.8, 10.9, 12.9	60	3 000
12 x 1,5 x 90	DIN 960 5.8, 8.8, 10.9, 12.9	60	3 000
12 x 1,5 x 95	DIN 960 5.8, 8.8, 10.9, 12.9	50	3 000

12 x 1,5 x 100	DIN 960 5.8, 8.8, 10.9, 12.9	50	3 000
12 x 1,5 x 105	DIN 960 5.8, 8.8, 10.9, 12.9	50	3 000
12 x 1,5 x 110	DIN 960 5.8, 8.8, 10.9, 12.9	50	3 000
12 x 1,5 x 115	DIN 960 5.8, 8.8, 10.9, 12.9	25	3 000
12 x 1,5 x 120	DIN 960 5.8, 8.8, 10.9, 12.9	25	3 000
14 x 1,5 x 30	DIN 960 5.8, 8.8, 10.9, 12.9	50	3 000
14 x 1,5 x 35	DIN 960 5.8, 8.8, 10.9, 12.9	50	3 000
14 x 1,5 x 40	DIN 960 5.8, 8.8, 10.9, 12.9	50	3 000
14 x 1,5 x 45	DIN 960 5.8, 8.8, 10.9, 12.9	50	3 000
14 x 1,5 x 50	DIN 960 5.8, 8.8, 10.9, 12.9	50	3 000
14 x 1,5 x 55	DIN 960 5.8, 8.8, 10.9, 12.9	50	3 000
14 x 1,5 x 60	DIN 960 5.8, 8.8, 10.9, 12.9	50	3 000
14 x 1,5 x 65	DIN 960 5.8, 8.8, 10.9, 12.9	50	3 000
14 x 1,5 x 70	DIN 960 5.8, 8.8, 10.9, 12.9	50	3 000
14 x 1,5 x 75	DIN 960 5.8, 8.8, 10.9, 12.9	50	3 000
14 x 1,5 x 80	DIN 960 5.8, 8.8, 10.9, 12.9	50	3 000
14 x 1,5 x 85	DIN 960 5.8, 8.8, 10.9, 12.9	50	3 000
14 x 1,5 x 90	DIN 960 5.8, 8.8, 10.9, 12.9	50	3 000
14 x 1,5 x 95	DIN 960 5.8, 8.8, 10.9, 12.9	50	3 000
14 x 1,5 x 100	DIN 960 5.8, 8.8, 10.9, 12.9	50	3 000
14 x 1,5 x 105	DIN 960 5.8, 8.8, 10.9, 12.9	25	3 000
14 x 1,5 x 110	DIN 960 5.8, 8.8, 10.9, 12.9	25	3 000
14 x 1,5 x 115	DIN 960 5.8, 8.8, 10.9, 12.9	25	3 000
14 x 1,5 x 120	DIN 960 5.8, 8.8, 10.9, 12.9	25	3 000
14 x 1,5 x 125	DIN 960 5.8, 8.8, 10.9, 12.9	25	3 000
14 x 1,5 x 130	DIN 960 5.8, 8.8, 10.9, 12.9	25	3 000
14 x 1,5 x 140	DIN 960 5.8, 8.8, 10.9, 12.9	25	3 000
16 x 1,5 x 40	DIN 960 5.8, 8.8, 10.9, 12.9	50	2 000
16 x 1,5 x 45	DIN 960 5.8, 8.8, 10.9, 12.9	50	2 000
16 x 1,5 x 50	DIN 960 5.8, 8.8, 10.9, 12.9	50	2 000
16 x 1,5 x 55	DIN 960 5.8, 8.8, 10.9, 12.9	50	2 000
16 x 1,5 x 60	DIN 960 5.8, 8.8, 10.9, 12.9	50	2 000
16 x 1,5 x 65	DIN 960 5.8, 8.8, 10.9, 12.9	50	2 000
16 x 1,5 x 70	DIN 960 5.8, 8.8, 10.9, 12.9	50	2 000
16 x 1,5 x 75	DIN 960 5.8, 8.8, 10.9, 12.9	50	2 000
16 x 1,5 x 80	DIN 960 5.8, 8.8, 10.9, 12.9	50	2 000
16 x 1,5 x 85	DIN 960 5.8, 8.8, 10.9, 12.9	25	2 000
16 x 1,5 x 90	DIN 960 5.8, 8.8, 10.9, 12.9	25	2 000
16 x 1,5 x 95	DIN 960 5.8, 8.8, 10.9, 12.9	25	2 000
16 x 1,5 x 100	DIN 960 5.8, 8.8, 10.9, 12.9	25	2 000
16 x 1,5 x 105	DIN 960 5.8, 8.8, 10.9, 12.9	25	2 000
16 x 1,5 x 110	DIN 960 5.8, 8.8, 10.9, 12.9	25	2 000
16 x 1,5 x 115	DIN 960 5.8, 8.8, 10.9, 12.9	25	2 000
16 x 1,5 x 120	DIN 960 5.8, 8.8, 10.9, 12.9	25	2 000
16 x 1,5 x 125	DIN 960 5.8, 8.8, 10.9, 12.9	25	2 000
16 x 1,5 x 130	DIN 960 5.8, 8.8, 10.9, 12.9	25	2 000
16 x 1,5 x 140	DIN 960 5.8, 8.8, 10.9, 12.9	25	2 000
16 x 1,5 x 150	DIN 960 5.8, 8.8, 10.9, 12.9	25	2 000
16 x 1,5 x 160	DIN 960 5.8, 8.8, 10.9, 12.9	25	2 000
18 x 1,5 x 55	DIN 960 5.8, 8.8, 10.9, 12.9	25	2 000

18 x 1,5 x 60	DIN 960 5.8, 8.8, 10.9, 12.9	25	2 000
18 x 1,5 x 65	DIN 960 5.8, 8.8, 10.9, 12.9	25	2 000
18 x 1,5 x 70	DIN 960 5.8, 8.8, 10.9, 12.9	25	2 000
18 x 1,5 x 75	DIN 960 5.8, 8.8, 10.9, 12.9	25	2 000
18 x 1,5 x 80	DIN 960 5.8, 8.8, 10.9, 12.9	25	2 000
18 x 1,5 x 85	DIN 960 5.8, 8.8, 10.9, 12.9	25	2 000
18 x 1,5 x 90	DIN 960 5.8, 8.8, 10.9, 12.9	25	2 000
18 x 1,5 x 95	DIN 960 5.8, 8.8, 10.9, 12.9	25	2 000
18 x 1,5 x 100	DIN 960 5.8, 8.8, 10.9, 12.9	20	2 000
18 x 1,5 x 105	DIN 960 5.8, 8.8, 10.9, 12.9	20	2 000
18 x 1,5 x 110	DIN 960 5.8, 8.8, 10.9, 12.9	20	2 000
18 x 1,5 x 115	DIN 960 5.8, 8.8, 10.9, 12.9	20	2 000
18 x 1,5 x 120	DIN 960 5.8, 8.8, 10.9, 12.9	10	2 000
18 x 1,5 x 125	DIN 960 5.8, 8.8, 10.9, 12.9	10	2 000
18 x 1,5 x 130	DIN 960 5.8, 8.8, 10.9, 12.9	10	2 000
18 x 1,5 x 140	DIN 960 5.8, 8.8, 10.9, 12.9	10	2 000
20 x 1,5 x 60	DIN 960 5.8, 8.8, 10.9, 12.9	25	2 000
20 x 1,5 x 65	DIN 960 5.8, 8.8, 10.9, 12.9	25	2 000
20 x 1,5 x 70	DIN 960 5.8, 8.8, 10.9, 12.9	25	2 000
20 x 1,5 x 75	DIN 960 5.8, 8.8, 10.9, 12.9	25	2 000
20 x 1,5 x 80	DIN 960 5.8, 8.8, 10.9, 12.9	25	2 000
20 x 1,5 x 85	DIN 960 5.8, 8.8, 10.9, 12.9	20	2 000
20 x 1,5 x 90	DIN 960 5.8, 8.8, 10.9, 12.9	20	2 000
20 x 1,5 x 95	DIN 960 5.8, 8.8, 10.9, 12.9	20	2 000
20 x 1,5 x 100	DIN 960 5.8, 8.8, 10.9, 12.9	20	2 000
20 x 1,5 x 105	DIN 960 5.8, 8.8, 10.9, 12.9	10	2 000
20 x 1,5 x 110	DIN 960 5.8, 8.8, 10.9, 12.9	10	2 000
20 x 1,5 x 115	DIN 960 5.8, 8.8, 10.9, 12.9	10	2 000
20 x 1,5 x 120	DIN 960 5.8, 8.8, 10.9, 12.9	10	2 000
20 x 1,5 x 125	DIN 960 5.8, 8.8, 10.9, 12.9	10	2 000
20 x 1,5 x 130	DIN 960 5.8, 8.8, 10.9, 12.9	10	2 000
20 x 1,5 x 140	DIN 960 5.8, 8.8, 10.9, 12.9	10	2 000
20 x 1,5 x 150	DIN 960 5.8, 8.8, 10.9, 12.9	10	2 000
20 x 1,5 x 160	DIN 960 5.8, 8.8, 10.9, 12.9	10	2 000

DIN 961 (5.8, 8.8, 10.9, 12.9)

Šestihranné šrouby s jemným závitem

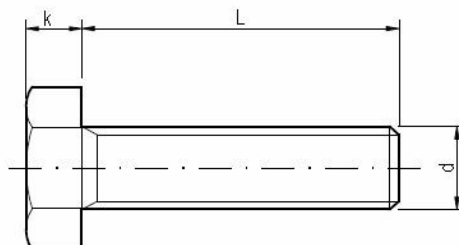
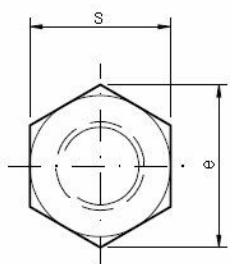
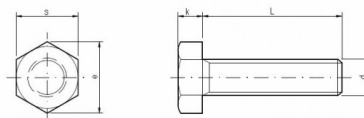

Specifikace

d	k	s	e
M 8	5,30	13,00	14,38

M 10	6,40	17,00	18,9
M 12	7,50	19,00	21,1
M 14	8,80	22,00	24,49
M16	10,00	24,00	26,75
M 18	11,50	27,00	30,14
M 20	12,50	30,00	33,53

Balení

Rozměr	Norma	krabice/ks	minimální objednáací množství/ks
8 x 1 x 12	DIN 961 5.8, 8.8, 10.9, 12.9	500	6 000
8 x 1 x 14	DIN 961 5.8, 8.8, 10.9, 12.9	400	6 000
8 x 1 x 18	DIN 961 5.8, 8.8, 10.9, 12.9	400	6 000
8 x 1 x 20	DIN 961 5.8, 8.8, 10.9, 12.9	300	6 000
8 x 1 x 22	DIN 961 5.8, 8.8, 10.9, 12.9	300	6 000
8 x 1 x 25	DIN 961 5.8, 8.8, 10.9, 12.9	300	6 000
8 x 1 x 28	DIN 961 5.8, 8.8, 10.9, 12.9	250	6 000
8 x 1 x 30	DIN 961 5.8, 8.8, 10.9, 12.9	250	6 000
8 x 1 x 35	DIN 961 5.8, 8.8, 10.9, 12.9	200	6 000
8 x 1 x 40	DIN 961 5.8, 8.8, 10.9, 12.9	200	6 000
8 x 1 x 45	DIN 961 5.8, 8.8, 10.9, 12.9	150	6 000
8 x 1 x 50	DIN 961 5.8, 8.8, 10.9, 12.9	150	6 000
8 x 1 x 55	DIN 961 5.8, 8.8, 10.9, 12.9	100	6 000
8 x 1 x 60	DIN 961 5.8, 8.8, 10.9, 12.9	100	6 000
8 x 1 x 65	DIN 961 5.8, 8.8, 10.9, 12.9	200	6 000
8 x 1 x 70	DIN 961 5.8, 8.8, 10.9, 12.9	200	6 000
8 x 1 x 75	DIN 961 5.8, 8.8, 10.9, 12.9	150	6 000
8 x 1 x 80	DIN 961 5.8, 8.8, 10.9, 12.9	150	6 000
10 x 1 x 18	DIN 961 5.8, 8.8, 10.9, 12.9	200	5 000
10 x 1 x 20	DIN 961 5.8, 8.8, 10.9, 12.9	200	5 000
10 x 1 x 22	DIN 961 5.8, 8.8, 10.9, 12.9	150	5 000
10 x 1 x 25	DIN 961 5.8, 8.8, 10.9, 12.9	150	5 000
10 x 1 x 28	DIN 961 5.8, 8.8, 10.9, 12.9	150	5 000
10 x 1 x 30	DIN 961 5.8, 8.8, 10.9, 12.9	150	5 000
10 x 1 x 35	DIN 961 5.8, 8.8, 10.9, 12.9	100	5 000
10 x 1 x 40	DIN 961 5.8, 8.8, 10.9, 12.9	100	5 000
10 x 1 x 45	DIN 961 5.8, 8.8, 10.9, 12.9	100	5 000
10 x 1 x 50	DIN 961 5.8, 8.8, 10.9, 12.9	100	5 000
10 x 1 x 55	DIN 961 5.8, 8.8, 10.9, 12.9	150	5 000
10 x 1 x 60	DIN 961 5.8, 8.8, 10.9, 12.9	150	5 000
10 x 1 x 65	DIN 961 5.8, 8.8, 10.9, 12.9	150	5 000
10 x 1 x 70	DIN 961 5.8, 8.8, 10.9, 12.9	100	5 000
10 x 1 x 75	DIN 961 5.8, 8.8, 10.9, 12.9	100	5 000
10 x 1 x 80	DIN 961 5.8, 8.8, 10.9, 12.9	100	5 000
10 x 1 x 85	DIN 961 5.8, 8.8, 10.9, 12.9	100	5 000
10 x 1,25 x 18	DIN 961 5.8, 8.8, 10.9, 12.9	200	5 000
10 x 1,25 x 20	DIN 961 5.8, 8.8, 10.9, 12.9	200	5 000
10 x 1,25 x 22	DIN 961 5.8, 8.8, 10.9, 12.9	150	5 000
10 x 1,25 x 25	DIN 961 5.8, 8.8, 10.9, 12.9	150	5 000
10 x 1,25 x 28	DIN 961 5.8, 8.8, 10.9, 12.9	150	5 000
10 x 1,25 x 30	DIN 961 5.8, 8.8, 10.9, 12.9	150	5 000

10 x 1,25 x 35	DIN 961 5.8, 8.8, 10.9, 12.9	100	5 000
10 x 1,25 x 40	DIN 961 5.8, 8.8, 10.9, 12.9	100	5 000
10 x 1,25 x 45	DIN 961 5.8, 8.8, 10.9, 12.9	100	5 000
10 x 1,25 x 50	DIN 961 5.8, 8.8, 10.9, 12.9	100	5 000
10 x 1,25 x 55	DIN 961 5.8, 8.8, 10.9, 12.9	150	5 000
10 x 1,25 x 60	DIN 961 5.8, 8.8, 10.9, 12.9	150	5 000
10 x 1,25 x 65	DIN 961 5.8, 8.8, 10.9, 12.9	150	5 000
10 x 1,25 x 70	DIN 961 5.8, 8.8, 10.9, 12.9	100	5 000
10 x 1,25 x 75	DIN 961 5.8, 8.8, 10.9, 12.9	100	5 000
10 x 1,25 x 80	DIN 961 5.8, 8.8, 10.9, 12.9	100	5 000
10 x 1,25 x 85	DIN 961 5.8, 8.8, 10.9, 12.9	100	5 000
12 x 1,25 x 20	DIN 961 5.8, 8.8, 10.9, 12.9	250	3 000
12 x 1,25 x 22	DIN 961 5.8, 8.8, 10.9, 12.9	250	3 000
12 x 1,25 x 25	DIN 961 5.8, 8.8, 10.9, 12.9	250	3 000
12 x 1,25 x 30	DIN 961 5.8, 8.8, 10.9, 12.9	200	3 000
12 x 1,25 x 35	DIN 961 5.8, 8.8, 10.9, 12.9	150	3 000
12 x 1,25 x 40	DIN 961 5.8, 8.8, 10.9, 12.9	150	3 000
12 x 1,25 x 45	DIN 961 5.8, 8.8, 10.9, 12.9	150	3 000
12 x 1,25 x 50	DIN 961 5.8, 8.8, 10.9, 12.9	100	3 000
12 x 1,25 x 55	DIN 961 5.8, 8.8, 10.9, 12.9	100	3 000
12 x 1,25 x 60	DIN 961 5.8, 8.8, 10.9, 12.9	100	3 000
12 x 1,25 x 65	DIN 961 5.8, 8.8, 10.9, 12.9	100	3 000
12 x 1,25 x 70	DIN 961 5.8, 8.8, 10.9, 12.9	80	3 000
12 x 1,25 x 75	DIN 961 5.8, 8.8, 10.9, 12.9	80	3 000
12 x 1,25 x 80	DIN 961 5.8, 8.8, 10.9, 12.9	80	3 000
12 x 1,5 x 20	DIN 961 5.8, 8.8, 10.9, 12.9	250	3 000
12 x 1,5 x 22	DIN 961 5.8, 8.8, 10.9, 12.9	250	3 000
12 x 1,5 x 25	DIN 961 5.8, 8.8, 10.9, 12.9	250	3 000
12 x 1,5 x 30	DIN 961 5.8, 8.8, 10.9, 12.9	200	3 000
12 x 1,5 x 35	DIN 961 5.8, 8.8, 10.9, 12.9	150	3 000
12 x 1,5 x 40	DIN 961 5.8, 8.8, 10.9, 12.9	150	3 000
12 x 1,5 x 45	DIN 961 5.8, 8.8, 10.9, 12.9	150	3 000
12 x 1,5 x 50	DIN 961 5.8, 8.8, 10.9, 12.9	100	3 000
12 x 1,5 x 55	DIN 961 5.8, 8.8, 10.9, 12.9	100	3 000
12 x 1,5 x 60	DIN 961 5.8, 8.8, 10.9, 12.9	100	3 000
12 x 1,5 x 65	DIN 961 5.8, 8.8, 10.9, 12.9	100	3 000
12 x 1,5 x 70	DIN 961 5.8, 8.8, 10.9, 12.9	80	3 000
12 x 1,5 x 75	DIN 961 5.8, 8.8, 10.9, 12.9	80	3 000
12 x 1,5 x 80	DIN 961 5.8, 8.8, 10.9, 12.9	80	3 000
14 x 1,5 x 20	DIN 961 5.8, 8.8, 10.9, 12.9	50	3 000
14 x 1,5 x 22	DIN 961 5.8, 8.8, 10.9, 12.9	50	3 000
14 x 1,5 x 25	DIN 961 5.8, 8.8, 10.9, 12.9	50	3 000
14 x 1,5 x 30	DIN 961 5.8, 8.8, 10.9, 12.9	50	3 000
14 x 1,5 x 35	DIN 961 5.8, 8.8, 10.9, 12.9	50	3 000
14 x 1,5 x 40	DIN 961 5.8, 8.8, 10.9, 12.9	50	3 000
14 x 1,5 x 45	DIN 961 5.8, 8.8, 10.9, 12.9	50	3 000
14 x 1,5 x 50	DIN 961 5.8, 8.8, 10.9, 12.9	50	3 000
14 x 1,5 x 55	DIN 961 5.8, 8.8, 10.9, 12.9	50	3 000
14 x 1,5 x 60	DIN 961 5.8, 8.8, 10.9, 12.9	50	3 000
14 x 1,5 x 65	DIN 961 5.8, 8.8, 10.9, 12.9	50	3 000

14 x 1,5 x 70	DIN 961 5.8, 8.8, 10.9, 12.9	50	3 000
14 x 1,5 x 75	DIN 961 5.8, 8.8, 10.9, 12.9	50	3 000
14 x 1,5 x 80	DIN 961 5.8, 8.8, 10.9, 12.9	50	3 000
16 x 1,5 x 25	DIN 961 5.8, 8.8, 10.9, 12.9	50	2 000
16 x 1,5 x 28	DIN 961 5.8, 8.8, 10.9, 12.9	50	2 000
16 x 1,5 x 30	DIN 961 5.8, 8.8, 10.9, 12.9	50	2 000
16 x 1,5 x 35	DIN 961 5.8, 8.8, 10.9, 12.9	50	2 000
16 x 1,5 x 40	DIN 961 5.8, 8.8, 10.9, 12.9	50	2 000
16 x 1,5 x 45	DIN 961 5.8, 8.8, 10.9, 12.9	50	2 000
16 x 1,5 x 50	DIN 961 5.8, 8.8, 10.9, 12.9	50	2 000
16 x 1,5 x 55	DIN 961 5.8, 8.8, 10.9, 12.9	50	2 000
16 x 1,5 x 60	DIN 961 5.8, 8.8, 10.9, 12.9	50	2 000
16 x 1,5 x 65	DIN 961 5.8, 8.8, 10.9, 12.9	50	2 000
16 x 1,5 x 70	DIN 961 5.8, 8.8, 10.9, 12.9	50	2 000
16 x 1,5 x 75	DIN 961 5.8, 8.8, 10.9, 12.9	50	2 000
16 x 1,5 x 80	DIN 961 5.8, 8.8, 10.9, 12.9	50	2 000
18 x 1,5 x 25	DIN 961 5.8, 8.8, 10.9, 12.9	25	2 000
18 x 1,5 x 28	DIN 961 5.8, 8.8, 10.9, 12.9	25	2 000
18 x 1,5 x 30	DIN 961 5.8, 8.8, 10.9, 12.9	25	2 000
18 x 1,5 x 35	DIN 961 5.8, 8.8, 10.9, 12.9	25	2 000
18 x 1,5 x 40	DIN 961 5.8, 8.8, 10.9, 12.9	25	2 000
18 x 1,5 x 45	DIN 961 5.8, 8.8, 10.9, 12.9	25	2 000
18 x 1,5 x 50	DIN 961 5.8, 8.8, 10.9, 12.9	25	2 000
18 x 1,5 x 55	DIN 961 5.8, 8.8, 10.9, 12.9	25	2 000
18 x 1,5 x 60	DIN 961 5.8, 8.8, 10.9, 12.9	25	2 000
18 x 1,5 x 65	DIN 961 5.8, 8.8, 10.9, 12.9	25	2 000
18 x 1,5 x 70	DIN 961 5.8, 8.8, 10.9, 12.9	25	2 000
18 x 1,5 x 75	DIN 961 5.8, 8.8, 10.9, 12.9	25	2 000
18 x 1,5 x 80	DIN 961 5.8, 8.8, 10.9, 12.9	25	2 000
20 x 1,5 x 25	DIN 961 5.8, 8.8, 10.9, 12.9	25	2 000
20 x 1,5 x 28	DIN 961 5.8, 8.8, 10.9, 12.9	25	2 000
20 x 1,5 x 30	DIN 961 5.8, 8.8, 10.9, 12.9	25	2 000
20 x 1,5 x 35	DIN 961 5.8, 8.8, 10.9, 12.9	25	2 000
20 x 1,5 x 40	DIN 961 5.8, 8.8, 10.9, 12.9	25	2 000
20 x 1,5 x 45	DIN 961 5.8, 8.8, 10.9, 12.9	25	2 000
20 x 1,5 x 50	DIN 961 5.8, 8.8, 10.9, 12.9	25	2 000
20 x 1,5 x 55	DIN 961 5.8, 8.8, 10.9, 12.9	25	2 000
20 x 1,5 x 60	DIN 961 5.8, 8.8, 10.9, 12.9	25	2 000
20 x 1,5 x 65	DIN 961 5.8, 8.8, 10.9, 12.9	25	2 000
20 x 1,5 x 70	DIN 961 5.8, 8.8, 10.9, 12.9	25	2 000
20 x 1,5 x 75	DIN 961 5.8, 8.8, 10.9, 12.9	25	2 000
20 x 1,5 x 80	DIN 961 5.8, 8.8, 10.9, 12.9	25	2 000

KÖCKERLING - šrouby s kladívkovou hlavou

Šrouby s kladívkovou hlavou 10.9 s maticemi DIN 934 (8.8)

NEJČASTĚJŠÍ POUŽITÍ

Šrouby **do strojů Köckerling**

Kód originálního dílu **Köckerling 901933**



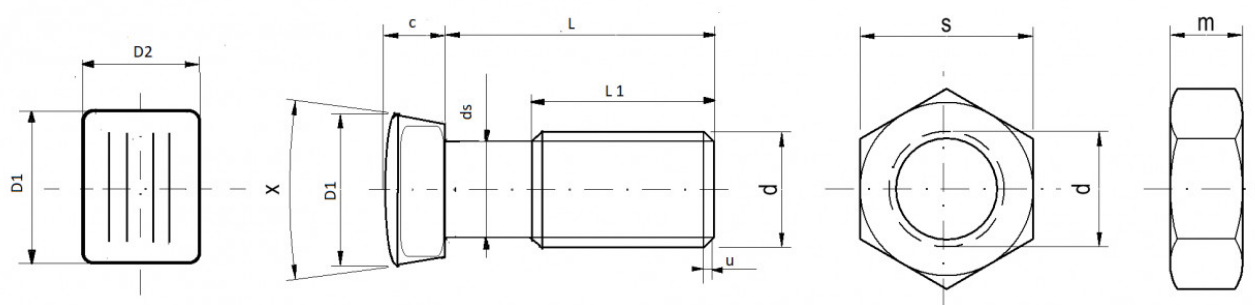

Specifikace

d	c	D1	D2	x	s	m
M 10	7,00	16,00	13,5	55°	17,00	8,00

Balení

		Balení bez matic	Balení s maticemi
10 x 55	KÖCKERLING 10.9	100	100/100
10 x 60	KÖCKERLING 10.9	150	100/100

Horsch 12 x 20

NEJČASTĚJŠÍ POUŽITÍ

Šrouby do strojů Horsch.

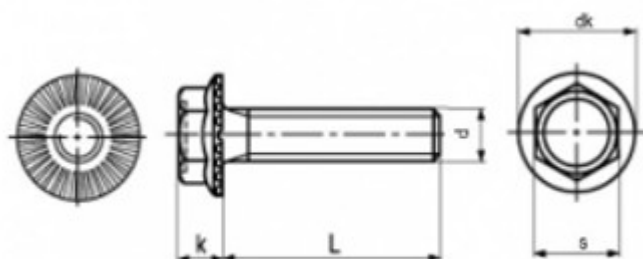
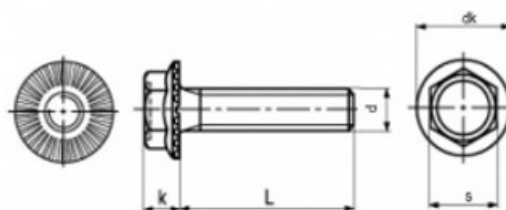

Specifikace

d	k	dk	s
M 12	10,00	23,50	17

Balení

Baleno v krabicích		Balení
12 x 20	Horsch 00360414	200

Maticice M14 Kverneland KK016013, KK016015

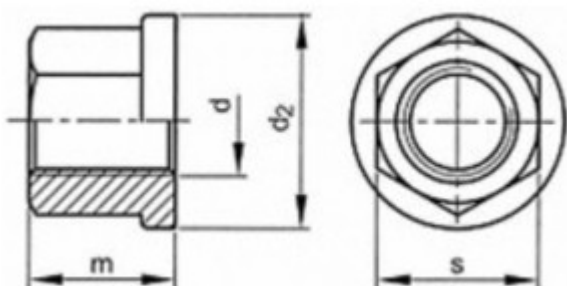

Specifikace

d	d2	m	s
M 14	25,00	12,00	19

Balení

Baleno v krabicích		Balení
M14	Matice /10/	100

Matice M12 Horsch

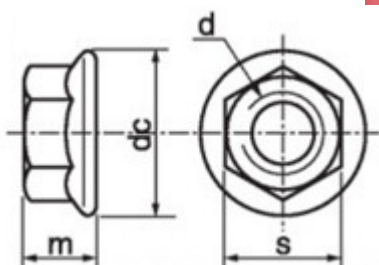
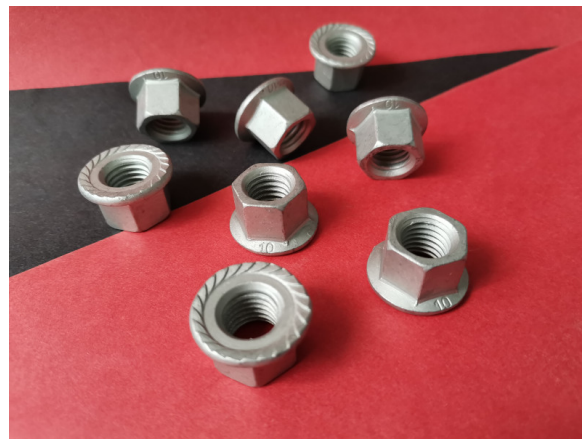

Specifikace

d	dc	m	s
M12	24,00	15,00	17

Balení

Baleno v krabicích.		Balení
M12	Matice /10/ 00360084	150